

Plain wersja 920 stojąca



Plain 920 x 688

kolor: Flat Black

Plain wersja 920 stojąca



Podłączenia:



Dostępne rozmiary:



920 x 80
1 sekcja (1)



920 x 278
3 sekcje (2+1)



920 x 360
4 sekcje (2+2)

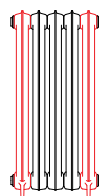

920 x 442
5 sekcji (2+3)

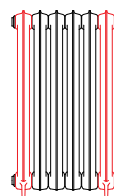

920 x 524
6 sekcji (2+4)

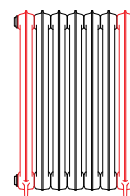

920 x 606
7 sekcji (2+5)

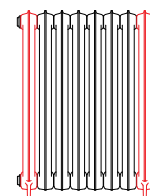

920 x 688
8 sekcji (2+6)

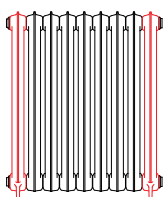

920 x 770
9 sekcji (2+7)

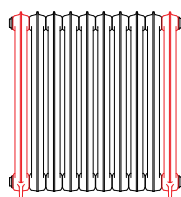

920 x 852
10 sekcji (2+8)

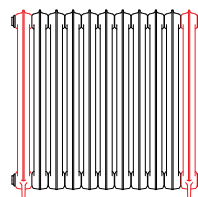

920 x 934
11 sekcji (2+9)

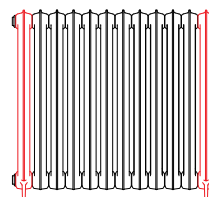

920 x 1016
12 sekcji (2+10)

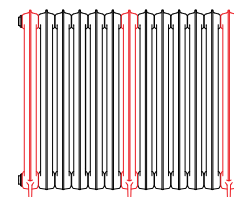

920 x 1098
13 sekcji (3+10)

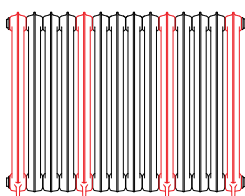

920 x 1180
14 sekcji (4+10)

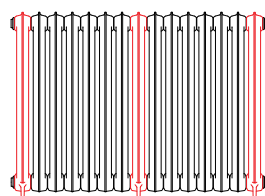

920 x 1262
15 sekcji (3+12)

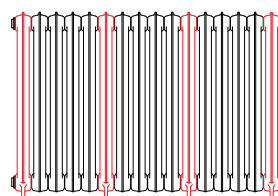

920 x 1344
16 sekcji (4+12)

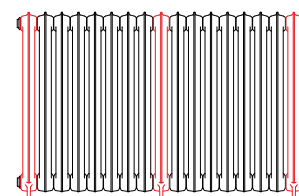

920 x 1426
17 sekcji (3+14)

Plain wersja 920 stojąca

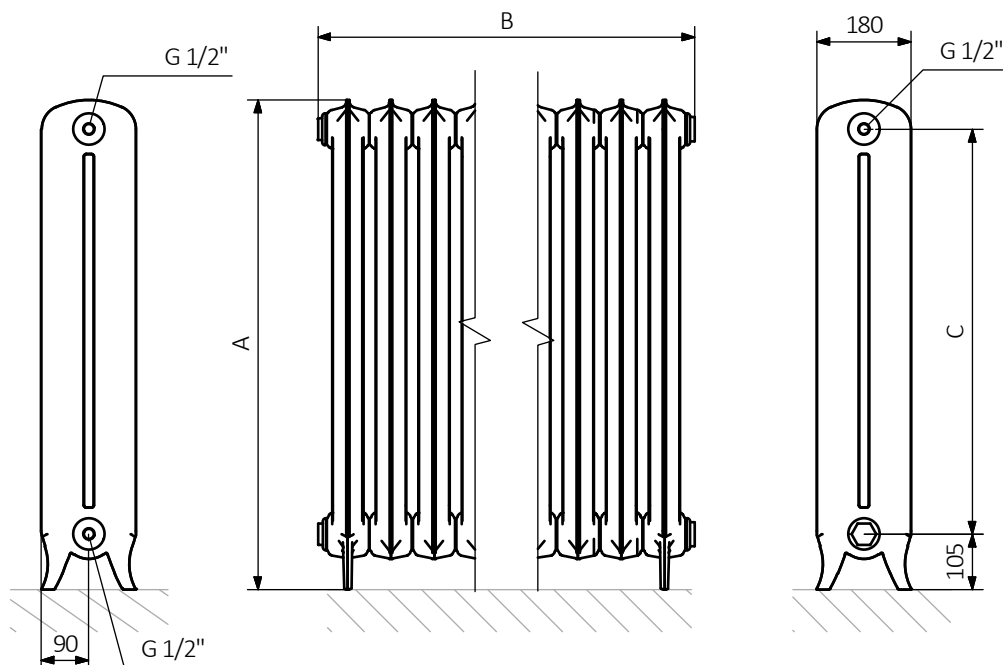

A – wysokość B – szerokość C – rozstaw podłączeń

Dane techniczne:

Ciśnienie robocze: 1000 kPa. Maksymalna temperatura pracy: 95°C.

A ↕	B ↔	C [mm]	75 65 20°C [W]	55 45 20°C [W]	⊞ [dm³]	⚖ [kg]
920	80	760	161	85	4,14	12,5
920	278	760	483	256	12,42	37,8
920	360	760	644	341	16,56	49,5
920	442	760	805	426	20,70	61,2
920	524	760	966	511	24,84	72,9
920	606	760	1127	597	28,98	84,6
920	688	760	1288	682	33,12	96,3
920	770	760	1449	767	37,26	108,0
920	852	760	1610	852	41,40	119,7
920	934	760	1771	937	45,54	132,2
920	1016	760	1932	1023	49,68	144,7
920	1098	760	2093	1108	53,82	155,6
920	1180	760	2254	1193	57,96	168,1
920	1262	760	2415	1278	62,10	179,0
920	1344	760	2576	1364	66,24	191,5
920	1426	760	2737	1449	70,38	202,4