

## 印刷说明(此页不制作)

序	维度		要求	备注
1	封面封底	材质	铜版纸	
		颜色	黑白	
2	内部印刷	材质	双胶纸	
		颜色	黑白	红色为更改标记，实物印刷黑色
3	来料尺寸		210*290	
4	张数		22张(44页)	

## 更改记录

序	更改时间	涉及页码	备注
1	240524	2	增加微可燃火焰标识
2	240711	11、26	增Q风管壳体、增磁环说明
3			

# Installation Operation Instruction Manual

## Air Conditioner Unit

- Installation should only be carried out by qualified technicians.
- For your convenience, please read this manual carefully and carry out all instructions in full.
- Please keep this manual in good condition for your reference.

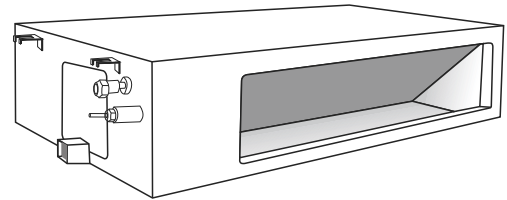
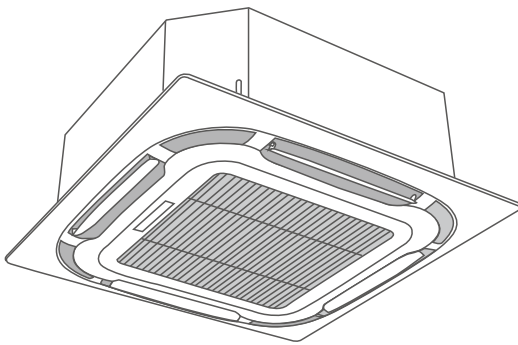



# Contents

Safety Precautions .....	2
Component name .....	7
Notices of installation.....	8
Installation of indoor unit-----Duct Type.....	11
Installation of indoor unit----- Ceiling cassette split air conditioner unit.....	13
Installation of indoor unit----- Ceiling &Floor Air Conditioner Unit.....	16
Installation of outdoor unit.....	20
Installation of tubing.....	22
Electrical connections.....	25
Wiring of indoor unit and outdoor unit.....	27
Commissioning.....	31
Operation instructions.....	32
Fault code - variable speed.....	33
Fault code - constant speed.....	35
Maintenance and service.....	36
Maintenance Notice.....	38

**Note: All the illustrations in this manual are for explanation purpose only. Your air conditioner may be slightly different. The actual shape shall prevail. They are subject to change without notice for future improvement.**

## Safety precautions

### Warning

**Warning: This air conditioner uses R32 flammable refrigerant.**

**Notes: Air conditioner with R32 refrigerant, if roughly treated, may cause serious harm to the human body or surrounding things.**

- \* The room space for the installation, use, repair, and storage of this air conditioner should be greater than 15m<sup>2</sup>.
- \* Do not use any methods to speed up defrost or to clean frosty parts except for particular recommended by manufacturer.
- \* Not pierce or burn air conditioner, and check the refrigerant pipeline whether be damaged.
- \* The air conditioner should be stored in a room without lasting fire source, for example, open flame, burning gas appliance, working electric heater and so on.
- \* Notice that the refrigerant may be tasteless.
- \* The storage of air conditioner should be able to prevent mechanical damage caused by accident.
- \* Maintenance or repair of air conditioners using R32 refrigerant must be carried out after security check to minimize risk of incidents.
- \* Air conditioner must be installed with stop valve cover.
- \* Please read the instruction carefully before installing, using and maintaining.



This symbol shows that this appliance uses a flammable refrigerant. If the refrigerant is leaked and exposed to an external ignition source, there is a risk of fire.  
(For the AC with CE-MARKING & CB-MARKING, IEC 60335-2-40+A1:2016)



This symbol shows that this appliance uses a low burning velocity material.  
(For the AC with CE-MARKING & CB-MARKING, IEC 60335-2-40+A1:2016)

\* The room space and refrigerant maximum charge requirements are shown below:



Room space (m <sup>2</sup> )	Refrigerant maximum charge requirements (Kg)
15-20	4.85
21-27	5.73
28-31	6.62
32-49	7.08
50-55	8.85
≥56	9.37

\* If Ceiling & Floor air conditioner unit use Wall-Mounted installation, the room space and refrigerant maximum charge requirements are shown below:



Room space (m <sup>2</sup> )	Refrigerant maximum charge requirements (Kg)
21-27	1.56
28-31	1.81
32-49	1.93
50-55	2.41
≥56	2.55

In order to prevent the risk of death, serious injury or damage to property please comply with the following important safety instructions.

The extent of possible harm is described by the following symbols.

 <b>Warning</b>	This symbol indicates danger of death or serious injury.
 <b>Caution</b>	This symbol indicates danger of death or damage to property.

The unit must be operated in accordance with the following symbols.

	This symbol indicates something which is strictly forbidden.
	This symbol indicates something which must be adhered to.

It is important that the unit is correctly commissioned after the installation is complete to ensure it is operating correctly.

After commissioning you should use this manual to explain to the user the correct method of operating the unit and its maintenance requirements.

### Protective measure

#### **Warning**

- Your air conditioner is not designed to be installed by yourself and should only be installed by a qualified, competent and trained technician.
  - The presence of Mains Voltage electricity and high pressure refrigerant gas make installing this system a specialist task which you should not attempt yourself.
  - Any electrical work on the air conditioner should only be carried out by a qualified, competent and trained technician and not by yourself.
- Ensure the electrical power is disconnected during service and maintenance.



#### **Warning**

- This unit must be correctly earthed. 
  - Incorrect grounding will cause earth leakage and electric shock.
  - Earth Leakage Protection must be installed.
- Failure to do so carries the risk of electric shock and fire.

















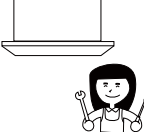





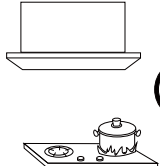

#### **Caution**

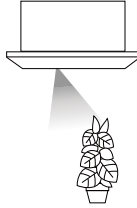
- Do not install either the indoor or outdoor unit in a place where flammable or explosive gases are present or there is a high risk of a fire or explosion occurring.
- Ensure the unit drain pipe work is properly connected and made so water leaks will occur.

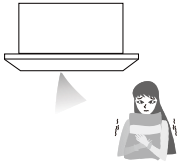

#### **Important**

- This unit is not suitable for operation by minors or disabled users.
- Children should be prevented from operating the air conditioner.

<p>Don't use flammable sprays near the air conditioner.</p> 	<p>IF there are some abnormalities (such as the smell of scorching), please shut down and cut off power supply.</p> 	
<p>Don't use open flame near the air conditioner.</p> 	<p>Don't use sub-standard or damaged wires.</p>  	
<p>Don't attempt to repair the air conditioner yourself.</p>  	<p>Don't put fingers or other objects into the air conditioner. Don't touch metal parts of the heat exchanger.</p>  	
<p>Your air conditioner is designed for comfort cooling or heating. It is not designed for any other purpose and specifically should not be used for storing food, animals, plants, precision instruments, art or antiques, nor any other special item. It is not designed for specialist computer rooms.</p>  	<p>Do not use naked flames where the air flow from the unit can reach directly. The air from the unit will interrupt the combustion process and either extinguish the flame or misdirect it. Either is a danger of fire or explosion.</p>  	
<p>Your air conditioner contains water and may also drip if the humidity of the room is too high. Do not, therefore, place any object under the unit which could be damaged in the event of water dripping on it.</p>  	<p>Do not direct the air from the unit directly onto animals or plants as this may be harmful to them.</p>  	
<p>Do not sit in in the cold air stream directly for long periods.</p>  	<p>Ensure the room properly ventilated.</p>	
<p>Check the air conditioner regularly to ensure correct operation and that nothing has become loose.</p> 	<p>Do not clean the air-conditioner with water.</p> 	<p>Before cleaning the air conditioner, cut off the power.</p>  

## Warning

- Do not attempt to install this unit yourself. Incorrect installation can cause refrigerant or water leakage, electric shock, fire or other to health and safety or property.
- Where the unit is installed must be solid enough to withstand the weight of the unit. If it is not then there is the danger of the structure collapsing or the unit falling creating a danger of serious injury or death.
- The installation should be mindful of potential damage by strong winds, earthquakes or other natural phenomena. These should not be able to cause the unit to fall over and cause an accident.
- The electrical installation should be in accordance with local and national specifications and only be carried out by qualified personnel in accordance with installation instructions. The air conditioner should have its own dedicated power supply.
- Ensure the power supply is of sufficient capacity for the unit , or there is a risk of fire, electric shock or other failure.
- The wiring should be made correctly using the specified cable and properly secured to avoid the risk of external forces causing the connections to come loose.  
Failure to do this runs the risks of electric shock or fire.
- Ensure the refrigerant pipe work is fully evacuated and leak tested and do not over charge with refrigerant. Over charging with refrigerant can cause a leak to occur after installation.
- Leaks can cause a high concentration of refrigerant in an area which may result in sudden death by asphyxiation.
- Do not carry out any electrical work unless the power supply has been disconnected.  
If the unit is installed in a small room there is danger of a leak causing the refrigerant gas concentration to exceed the maximum permissible for safe breathing and this can cause sudden death by asphyxiation. Please consult your dealer about preventative measures such as audible visual leak detectors.
- When making pipe connections be sure to use a torque wrench and tighten the flare nuts to the correct torque. Over and under tightened nuts can cause refrigerant gas to leak. Do not operate the compressor unit the pipe work has been correctly made, leak tested and evacuated.
- While performing installation or maintenance ensure that no foreign objects can enter the either the unit or pipe work.

## Caution

- Ensure the drain pipe is installed in accordance with the installation instructions and adequately insulated to protect against condensation forming. Badly installed drain pipe work can cause expensive damage due to water leaks.
- Your air conditioner contains sophisticated electronic controls which may be subject to interference from radios, televisions, mobile telephones or other electronic goods. Do not operate these items near to the air conditioner or they may cause the unit to fail.  
We suggest maintaining a distance from these items to indoor unit at least 1 meter and to the outdoor unit of at least 2 meter.  
Depending upon the type and frequency of the electromagnetic signal you may need to leave a longer distance than this.
- Ensure no following objects under the indoor unit:
  1. microwaves, ovens and other hot objects.
  2. computers and other high electrostatic appliances.
  3. sockets that plug frequently.The joints between indoor and outdoor unit shall not be reused, unless after re-flaring the pipe.

## **Forbidden**

- Do not try and install, service or remove the air conditioner yourself. Contact the dealer or service center.
- Do not mount this system in a vehicle, ship, aircraft or other place which will move while the unit is in operation.
- Do not install this unit where there will flammable or explosive gases present. If these leak and accumulate near the air conditioner then a fire or explosion may result.

## **Warning**

- Do not use any refrigerant other than the one indicated on the outdoor unit nameplate. Do not allow foreign bodies or moisture to enter the pipe work during installation and ensure the pipe work is fully leak tested and evacuated before running the unit. If the refrigerant gas becomes contaminated with moisture, air or other gases then unit will not perform correctly and there is a risk of leakage, explosion or other damage to the unit.
- Do not extend the power cable or use multiple power cables.
- Do not place the outdoor unit near balconies or anywhere children can climb onto it and potentially fall off and injure themselves.
- The indoor unit should be mounted at least 2.5 meters above the ground to prevent people from interfering with it.
- If there is a refrigerant leak during installation immediately ventilate the space thoroughly. Once the installation is complete carry out a thorough leak test of the system. Never allow refrigerant gas to make contact with sparks or naked flames and burning refrigerant releases poisonous gases.
- Ensure the electrical supply cable is properly protected and connections are made properly. Bad connections will cause the cable to overheat and potentially cause electric shocks or fire.
- An Earth leakage protector must be installed. The entire electrical installation should be checked by a qualified electrician to avoid the potential for electrical shocks or fire.
- The unit must be adequately earthed.   
Never connect the earth wire to gas or water pipes, lighting rods or telephone cables. Inadequate grounding of the earth cable may lead to the danger of serious injury or death by electric shock.
- This appliance can be used by children aged from 8 years and above and persons with reduced physical, sensory or mental capabilities or lack of experience and knowledge if they have been given supervision or instruction concerning use of the appliance in a safe way and understand the hazards involved. Children shall not play with the appliance. Cleaning and user maintenance shall not be made by children without supervision.  
(Only for the AC with CE-MARKING)
- This appliance is not intended for use by persons (including children) with reduced physical, sensory or mental capabilities, or lack of experience and knowledge, unless they have been given supervision or instruction concerning use of the appliance by a person responsible for their safety. Children should be supervised to ensure that they do not play with the appliance.  
(Except for the AC with CE-MARKING)

## **WEEE Warning**

Meaning of crossed out wheeled dustbin:

Do not dispose of electrical appliances as unsorted municipal waste, use separate collection facilities.

Contact your local government for information regarding the collection systems available.

If electrical appliances are disposed of in landfills or dumps, hazardous substances can leak into the groundwater and get into the food chain, damaging your health and well-being.

When replacing old appliances with new ones, the retailer is legally obligated to take back your old appliance for disposal at least free of charge.



**Component name**

**Indoor Unit:**

**Ceiling cassette split air conditioner unit**

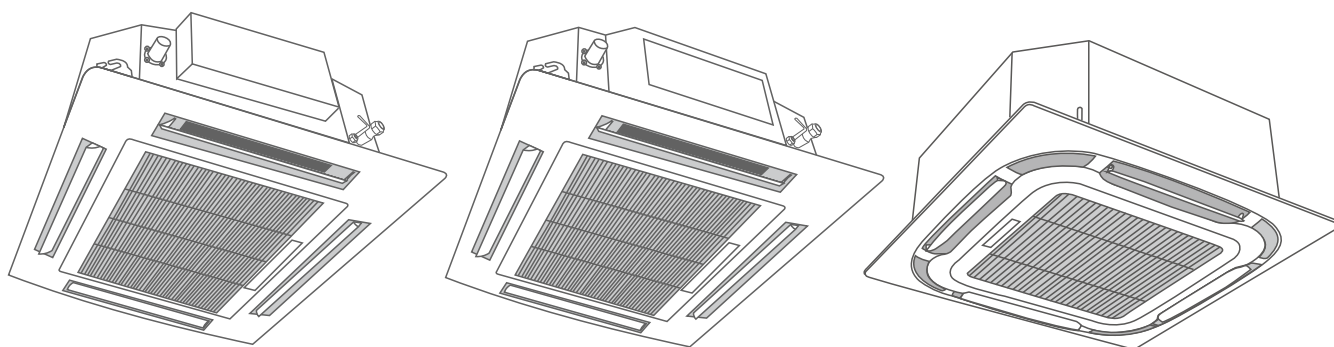

**Duct Type**

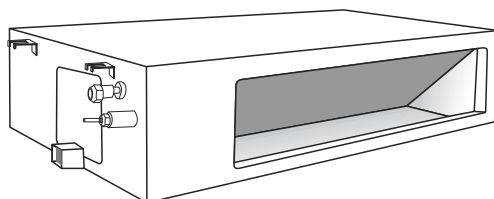

**Ceiling & Floor Air Conditioner Unit**

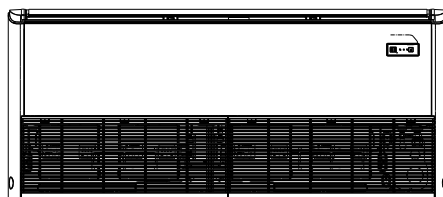

**Outdoor Unit:**

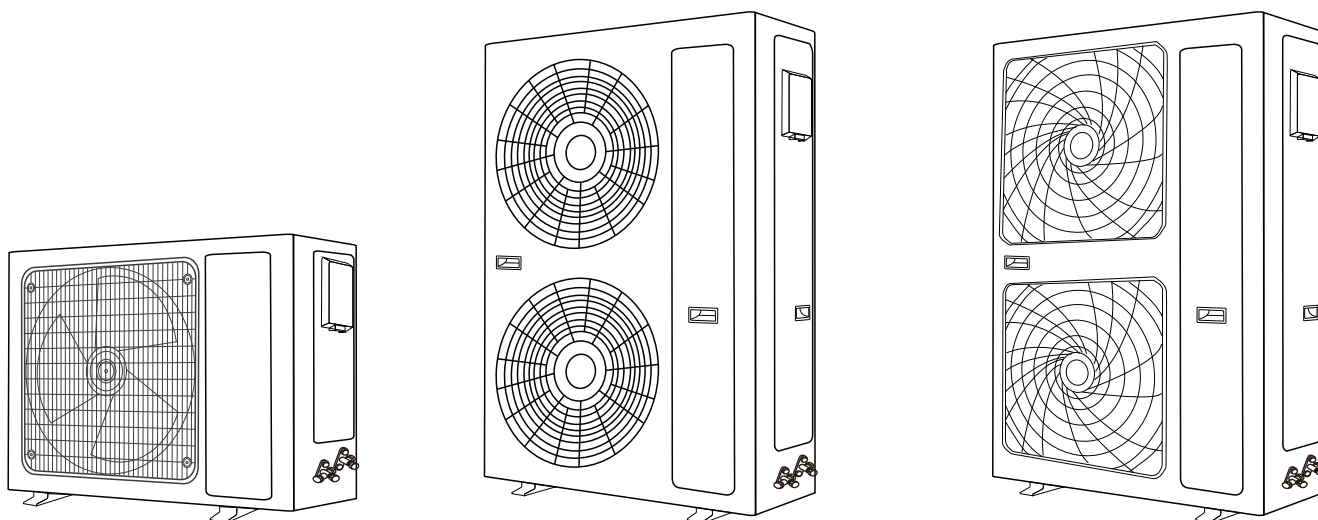

## Notices of installation

### Unpacking Inspection

1. Open the box and check air conditioner in area with good ventilation (open the door and window) and without ignition source. ( Note: Operators are required to wear anti-static devices)
2. It is necessary to check by professional whether there is refrigerant leakage before opening the box of outdoor machine; stop installing the air conditioner if leakage is found.
3. The fire prevention equipment and anti-static precautions shall be prepared well before checking. Then check the refrigerant pipeline to see if there is any collision traces, and whether the outlook is good.

### Safety Principles for Installing Air Conditioner

1. Fire prevention device shall be prepared before installation.
2. Keep installing site ventilated. (open the door and window)
3. Ignition source, smoking and calling is not allowed to exist in area where R32 refrigerant located.
4. Anti-static precautions in necessary for installing air conditioner, e.g. wear pure cotton clothes and gloves.
5. Keep leak detector in working state during the installation.
6. If R32 refrigerant leakage occurs during the installation, you shall immediately detect the concentration in indoor environment until it reaches a safe level. If refrigerant leakage affects the performance of the air conditioner, please immediately stop the operation, and the air conditioner must be vacuumed firstly and be returned to the maintenance station for processing.
7. Keep electric appliance, power switch, plug, socket, high temperature heat source and high static away from the area underneath sidelines of the indoor unit.
8. The air conditioner shall be installed in an accessible location to installation and maintenance, without obstacles that may block air inlets or outlets of indoor/outdoor units, and shall keep away from heat source, inflammable or explosive conditions.
9. When installing or repairing the air conditioner and the connecting line is not long enough, the entire connecting line shall be replaced with the connecting line of the original specification; extension is not allowed.
10. Use new connection pipe, unless re-flaring the pipe.

### Requirements For Installation Position

1. Avoid places of inflammable or explosive gas leakage or where there are strongly aggressive gases.
2. Avoid places subject to strong artificial electric/magnetic fields.
3. Avoid places subject to noise and resonance.
4. Avoid severe natural conditions (e.g. heavy lampblack, strong sandy wind, direct sunshine or high temperature heat sources).
5. Avoid places within the reach of children.
6. Shorten the connection between the indoor and outdoor units.
7. Select where it is easy to perform service and repair and where the ventilation good.
8. The outdoor unit shall not be installed in any way that could occupy an aisle, stairway, exit, fire escape, catwalk or any other public area.
9. The outdoor unit shall be installed as far as possible from the doors and windows of the neighbors as well as the green plants.

### Installation environment inspection

1. Check nameplate of outdoor unit to make sure whether the refrigerant is R32.
2. Check the floor space of the room. The space shall not be less than usable space (5m<sup>2</sup>) in the specification. The outdoor unit shall be installed at a well-ventilated place.
3. Check the surrounding environment of installation site: R32 shall not be installed in the enclosed reserved space of a building.
4. When using electric drill to make holes in the wall, check first whether there is pre-buried pipeline for water, electricity and gas. It is suggested to use the reserved hole in the roof of the wall.

## Correct installation

### Caution:

- When unpacking, open the carton, please remove the packing foam first, then take out the air conditioner.
- Do not touch the heat exchanger at the rear of the indoor unit with your hands or any other object!
- Handling with the handle and side angle, please handle with care, Do not drop the unit or allow it to fall during transport.
- When the outdoor unit is to be lifted, please use two slings longer than 8m and insert cushioning material between the slings and outdoor unit to avoid damaging the casing.

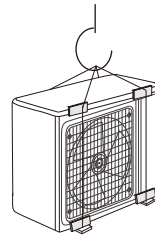
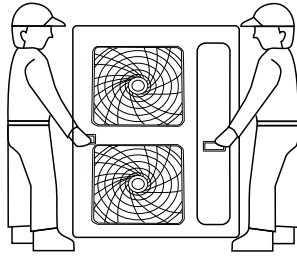

Preparation for installation accessories	Installation tools
<p>Before installation the following items are not included with the unit but will be required for the installation and should be obtained locally.</p> <ul style="list-style-type: none"> <li>● Four M12 suspension bolts</li> <li>● PVC drain pipe</li> <li>● Connection pipe</li> <li>● Heat insulation materials(PE, thickness is over 8mm) used for connecting pipe</li> <li>● Five large binding tapes and five small binding tapes</li> <li>● Outdoor power cable, and indoor and outdoor power connecting cable</li> </ul>	<p>Besides the common tools, during connecting the pipe the following tools are required:</p> <ul style="list-style-type: none"> <li>● Torque spanner(42 N•m, 65 N•m, 100 N•m)</li> <li>● Pipe cutter (cut copper pipe)</li> <li>● Refrigerant cylinder (when the pipe is lengthened, the refrigerant must be added)</li> <li>● Nitrogen cylinder ( to prevent oxidation and to clean pipe when weld pipe)</li> <li>● Pressure gauge</li> <li>● LPG</li> <li>● Pipe clamp</li> <li>● Welding torch</li> </ul>

## Installation drawing

This installation chart is for reference only

Power supply: single-phase 220-240V,50Hz/60Hz; hree-phase 380-415V,3N~,50Hz/60Hz.

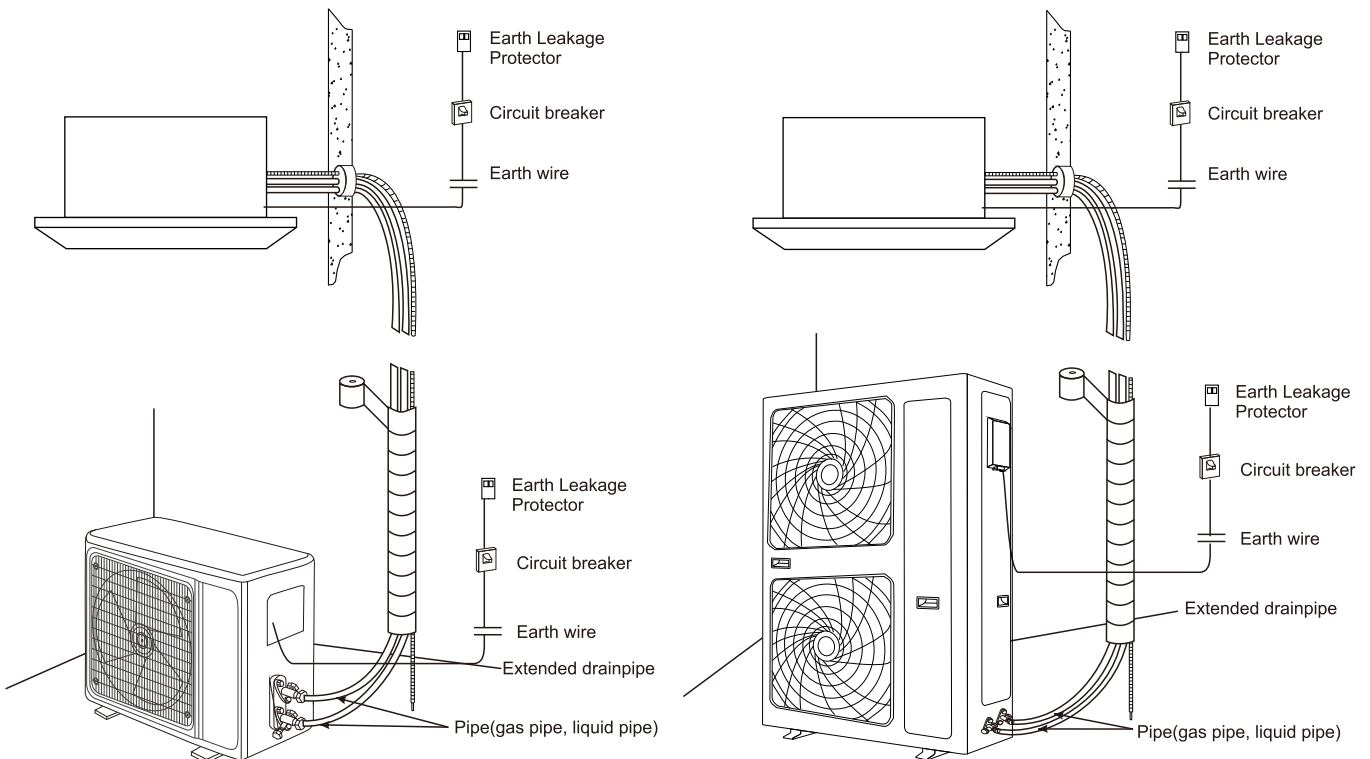

## Attention to Installation site of indoor unit

### For convenience of maintenance, please reserve a service port.

Ensure the following conditions are satisfied and confirm the position with the customer.

- 1.The position must allow the air to not be obstructed.
- 2.The distance away from the wall and obstacles is shown in the below drawing.
- 3.The installation site should be convenient for water draining (See " Installation of drainage pipe" for details).

### Warning

- 4.For ducted type indoor unit, the suspension site should be able to support the weight 4 times more than the indoor unit. There should be no increase in noise and vibration. If it needs to be reinforced, the installation should be carried on after reinforcement (if reinforcement is poor, the indoor unit will fall and cause damage).
- 5.The indoor unit must be away from sources of heat or steam and way from entrances.
- 6.The indoor unit position is near the power source (special line).
- 7.The indoor unit position must allow for easy connection to the outdoor unit.
- 8.The indoor unit position should keep away from direct sunlight and moisture.
- 9.The height inside the ceiling should reach the drainage requirements to ensure the installation of indoor unit.
- 10.The unit cannot be installed in the washhouse (it will cause electric shock).
- 11.In the inlet and outlet of indoor unit, protective barriers should be installed to prevent finger from inserting or contacting the fan with high speed and metal fin.

## Matter requiring attention

### Must carry out a full inspection to the following place before installation

- 1.In restaurants, kitchens and other eating places, dust, flour, grease steam and other cooking by products will easily attach to the indoor fan, heat exchanger and drain pump. This will cause the performance to reduce and cause the unit to spray water, leak and may lead to the drain pump or other components to fail. Please consider adopting the following improvement measures.

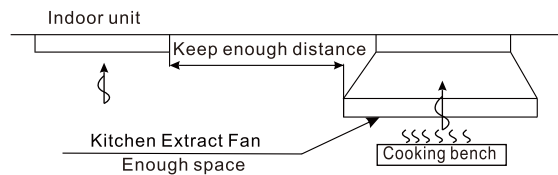

The capacity of the kitchen extract fan and extract hood should be great enough to ensure that the oil, steam, flour and other cooking products will be exhausted through it and not attracted into the air conditioner. The indoor unit should be far enough away from the cooking and food preparation equipment to ensure that cooking products are not attracted into the unit.

- 2.When installing the unit in a factory, ensure it is situated in a place where it will not be contaminated by oil, powder, iron filings or dust.
- 3.Do not install near potential sources of combustible gas.
- 4.Do not install where acidic or corrosive gases are present.

# Installation of indoor unit-----Duct Type

## The location of hoisting bolt

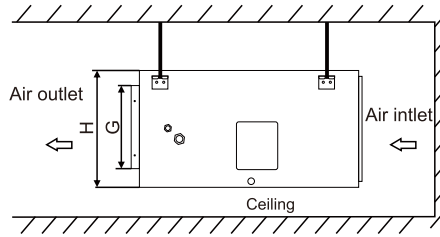
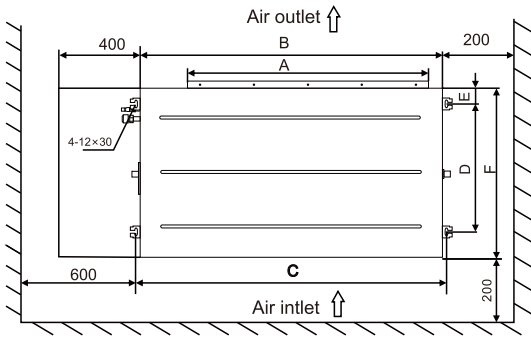

Packing Size (cm)	A mm	B mm	C mm	D mm	E mm	F mm	G mm	H mm
107*80*36	652	890	927	510	75	700	202	290
110*80*36	652	890	927	510	75	700	202	290
143*80*36	967	1250	1287	510	75	700	185	290
146*80*36	967	1250	1287	510	75	700	185	290
143*80*39	967	1250	1287	510	75	700	214	320
146*80*39	967	1250	1287	510	75	700	214	320
158*88*45	1117	1400	1437	585	75	775	273	380
161*88*45	1117	1400	1437	585	75	775	273	380
93*83*30	512	700	739	600	52	700	177	245
123*83*30	812	1000	1039	600	52	700	177	245
163*83*30	1212	1400	1439	600	52	700	177	245
100.5*58*27.5	532	700	750	412	23	460	110	200
130.5*58*27.5	832	1000	1050	412	23	460	110	200
71.5*53.5*25.5	367	550	594	350	50	450	145	198
86.5*53.5*25.5	517	700	744	350	50	450	145	198
106.5*53.5*25.5	717	900	944	350	50	450	145	198
126.5*53.5*25.5	917	1100	1144	350	50	450	145	198

## The suspension drawing of indoor unit

### ⚠ Warning

- Must seriously fasten bolts and nuts. The loosening would lead to air conditioner falling and so on.
- As shown, the indoor unit should be leaning to the drain hole to be convenient for drainage.

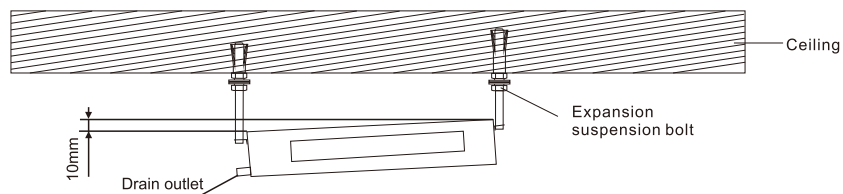

## Installation of duct

There are two installation methods of duct ,as follow.

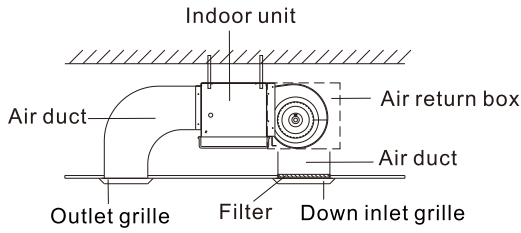

A

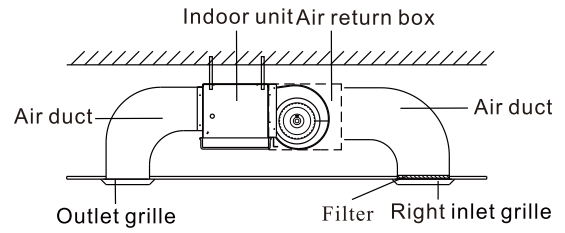

B

- Use canvas to connect the indoor unit and duct in order to reduce unnecessary vibration.

## Installation of drainage pipe

1.The drainage pipes should have good insulation measures. The specific steps are as follows:

- The drainage hoses should be tightly clamped with the inner water outlet and the drainage pipe respectively, then fix with a hoop , as shown in Fig ① .
- Wrap the heat insulation cotton on the drain insulation pipe and the hoop , as shown in Fig ② .
- Tighten the sponge with a bandage , as shown in Fig ③ .

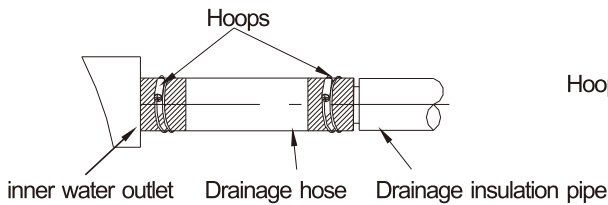

Fig ①

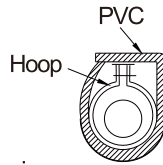

Fig ②

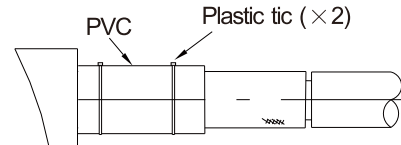
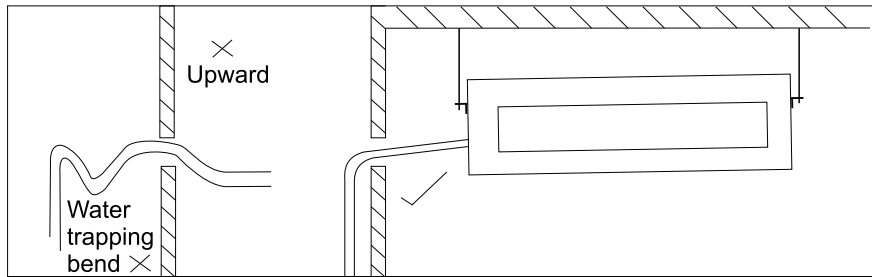

Fig ③

2.The drain pipe must have a downward gradient(1/50~1/100).

If the drain pipe is installed ups and downs or upward, it will lead to water back flow or leakage etc.



3.During pipe connection, do not use too much force to the drain joint of indoor unit.

4.The joint is PT1.

5. There is a drain hole on each side of indoor unit; unused drain pipe must be closed.

Note: The drain pipe must be wrapped heat insulation material, otherwise it will cause condensation or water drops.  
Heat insulation material: rubber insulatoin pipe with thickness more than 8mm.

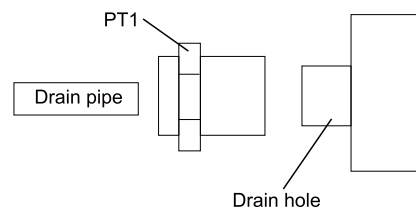
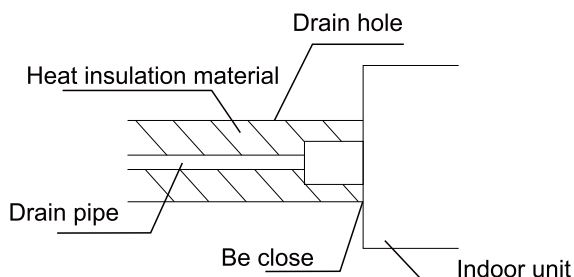

# Installation of indoor unit----- Ceiling cassette split air conditioner unit

## Select installation site

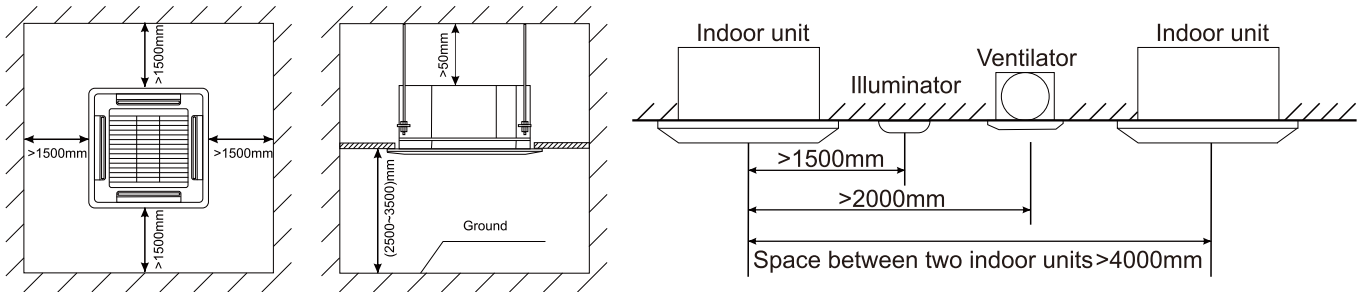

## The dimension of indoor unit

Ceiling cassette split air conditioner unit have four kinds of shapes, Fig A , Fig B, Fig C, and Fig D. Please choose the size according to the shape. the actual shape shall prevail.

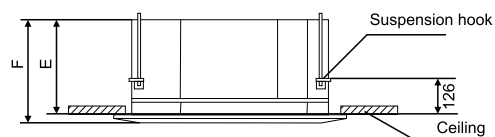
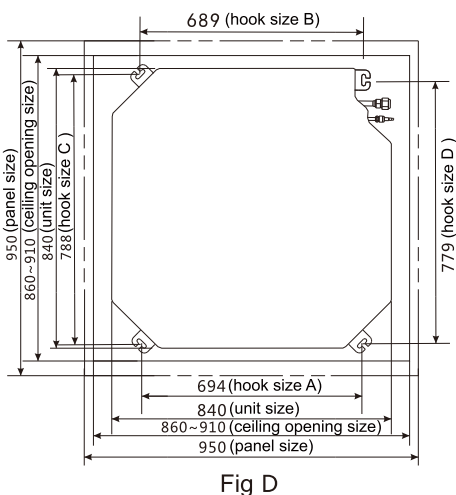
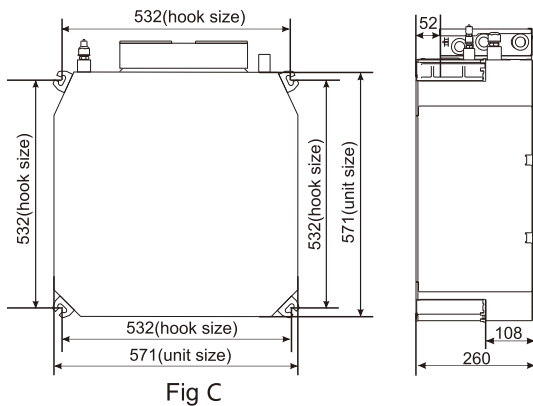
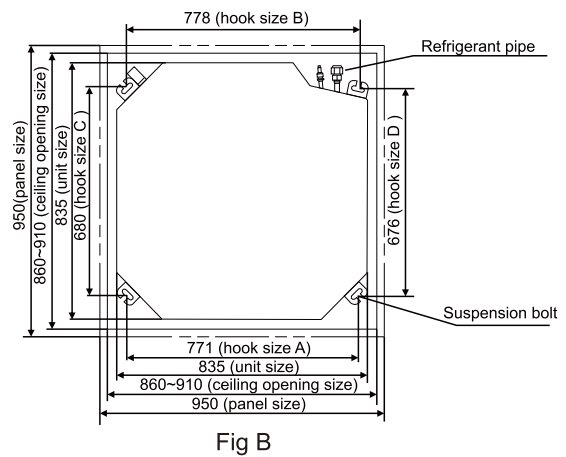
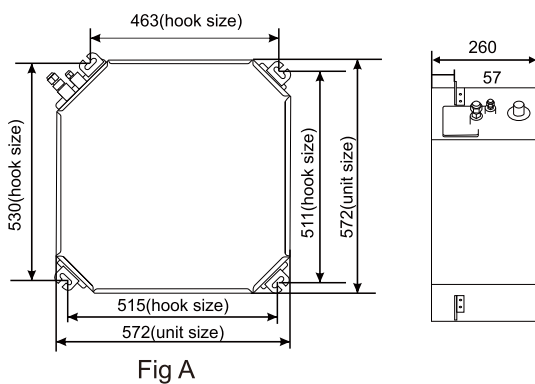

Packing Size (cm)	E mm	F mm
65.5*65.5*29.5	260	315
72.0*65.0*29.0	260	315
91.5*91.5*32	250	305
91.5*91.5*36	290	345

## Suspension foundation of the indoor unit

### 1. Select the suspension foundation

The suspension foundation is a structure of either wooden frame or reinforced concrete. It must be firm and reliable to bear the weight of more than 200kg and capable of bearing vibration for long periods.

### 2. Fixing of suspension foundation

Fix the suspension bolts as shown on the right either by a steel or by wooden bracket.

If this unit is installed on a sloping ceiling, a cushion block should be installed between the ceiling and the air outlet panel, in order to ensure that the unit is installed on a level surface.

This is as shown in the drawing as follow.

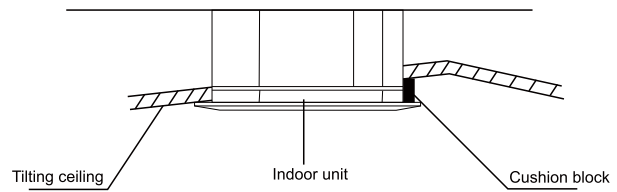
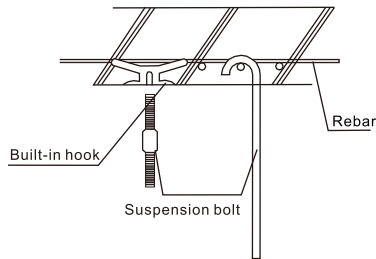

## Suspension of the indoor unit

The indoor unit should be suspended as shown in the sketch:

1. Adjust the relative position of the suspension hook on the suspension bolt.
2. Tighten the bolt and ensure that four hooks are in close contact with the nuts and washers, and the unit is suspended firmly and reliably onto the hooks.
3. Ensure it is secure and does not shake or sway after the unit is installed.
4. Ensure that the center of the indoor unit is in alignment with that of the opening in the ceiling.
5. Cassette unit with external electrical control box, installation refers to figure.

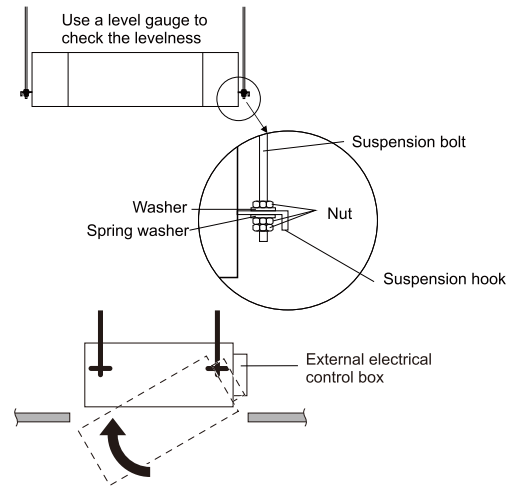

## Installation of drainage pipe

1. The drain pipe should be properly insulated to prevent the generation of condensation. It should be installed with a downward gradient.

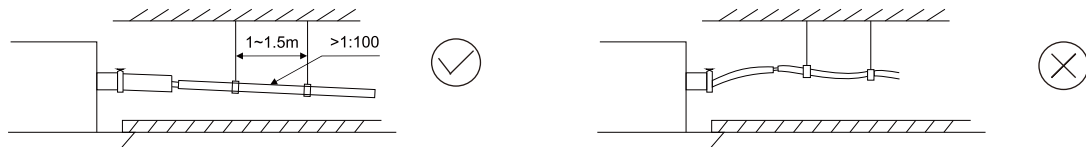

### ⚠ Caution

In order to ensure the drainage water come out successfully, the unit must be horizontal or declined to drain hose when finished installation.

2. The unit has a drain pump which will lift up to 1200mm. However after the pump stops, the water still in the pipe will drain back and may overflow the drain tray causing a protective stop. For this reason please install the drain pipe as shown on the right.

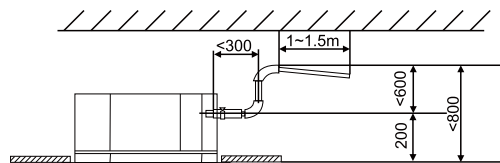

3. When draining multiple units into a common drain line, this common drain should be installed about 100mm below each unit drain outlet, as shown in the drawing on the right.



## Grille Installation

Please refer to the picture on the right.

The grille has four clips which attach to corresponding hangers on the unit and the grille should be positioned using these first. The grille is then fixed into the position by four bolts which are accessed through the four corner panels on the grille. The four connection bolts are located inside the inlet panel of the grille.

Note: During installation please ensure that the air vane motor in the grille corresponds to the position of the refrigerant pipe entry into the indoor unit.

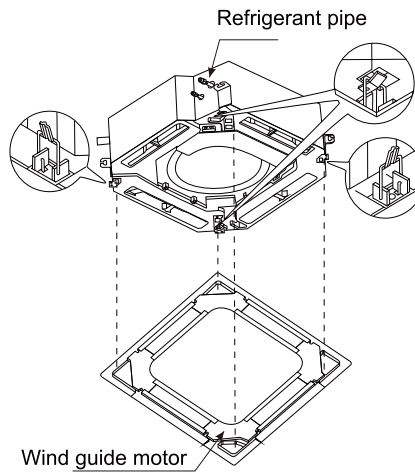

## Removing the air filter

1. Ensure the unit is switched off and the power is off.
2. Each unit has two retention clips on the grille. These must be pressed and then pushed to the open position.
3. The filter access panel may now be lowered allowing you to remove the filter from its four retaining clips.
4. Ensure the filter is fully clean and dry before replacing.
5. Ensure the retention clips on the grille are fastened position after replacing the filter.

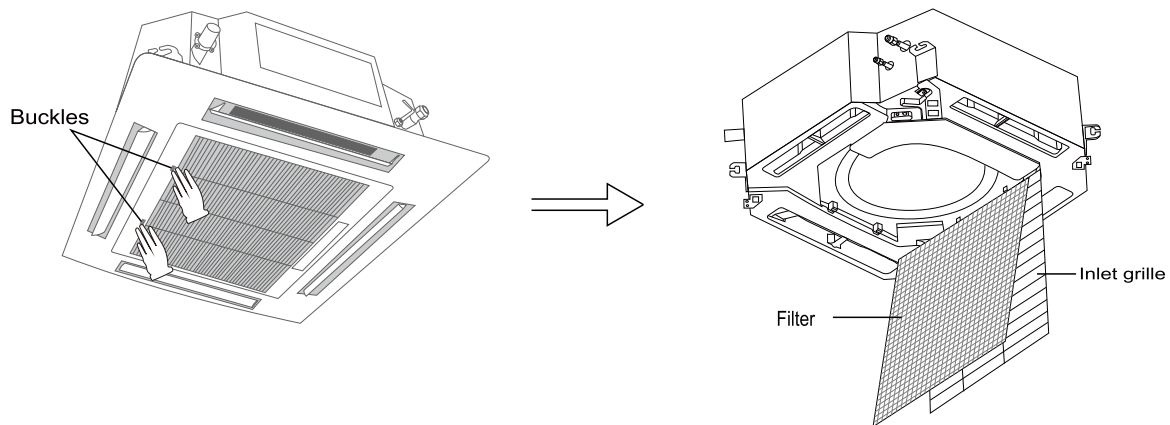

# Installation of indoor unit----- Ceiling & Floor Air Conditioner Unit(Type 1)

•Items to be checked at delivery

Items to be checked	Check column
Have you carried out field setting? (if necessary)	
Are the control box cover, the air filter and the suction grille attached?	
Does the cool air discharge during the cooling operation and the warm air discharge during heating operation comes out of the unit?	
Have you explained how to operate the air conditioner showing the operation manual to the customer?	
Have you explained the description of cooling, heating, program dry and automatic (cooling/heating) given in the operation manual to the customer?	
If you set the fan speed at thermostat OFF, did you explain the set fan speed to the customer?	
Have you handed the operation manual and the installation manual to the customer?	

• Points of the operation explanation

In addition to the general usage, since the items in the operation manual with the **⚠** WARNING and **⚠** CAUTION marks are likely to result in human bodily injuries and property damages, it is necessary not only to explain these items to the customer but also to have the customer read them. It is also necessary to explain the items of "NOT MAL-FUNCTION OF THE AIR CONDITIONER" to the customer and have the customer read them carefully.

## Selection of installation location

When unpacking and moving the indoor unit after unpacked, do not apply force to the piping (refrigerant and drain).

**1. Select the installation location that meets the following conditions and get approval of the customer.**

- Where the cool and warm air spreads evenly in the room.
- Where there is no obstacles in the air passage.
- Where drainage can be ensured.
- Where the ceiling lower surface is not inclined.
- Where there is sufficient strength to withstand the mass of the indoor unit (if the strength is insufficient, the indoor unit may vibrate and get in contact with the ceiling and generate unpleasant chattering noise).
- Where a space sufficient for installation and service can be ensured.
- Where the piping length between the indoor and the outdoor units is ensured within the allowable length. (Refer to the installation manual attached to the outdoor unit.)
- Where there is no risk of flammable gas leak.

**Required installation space (mm)**

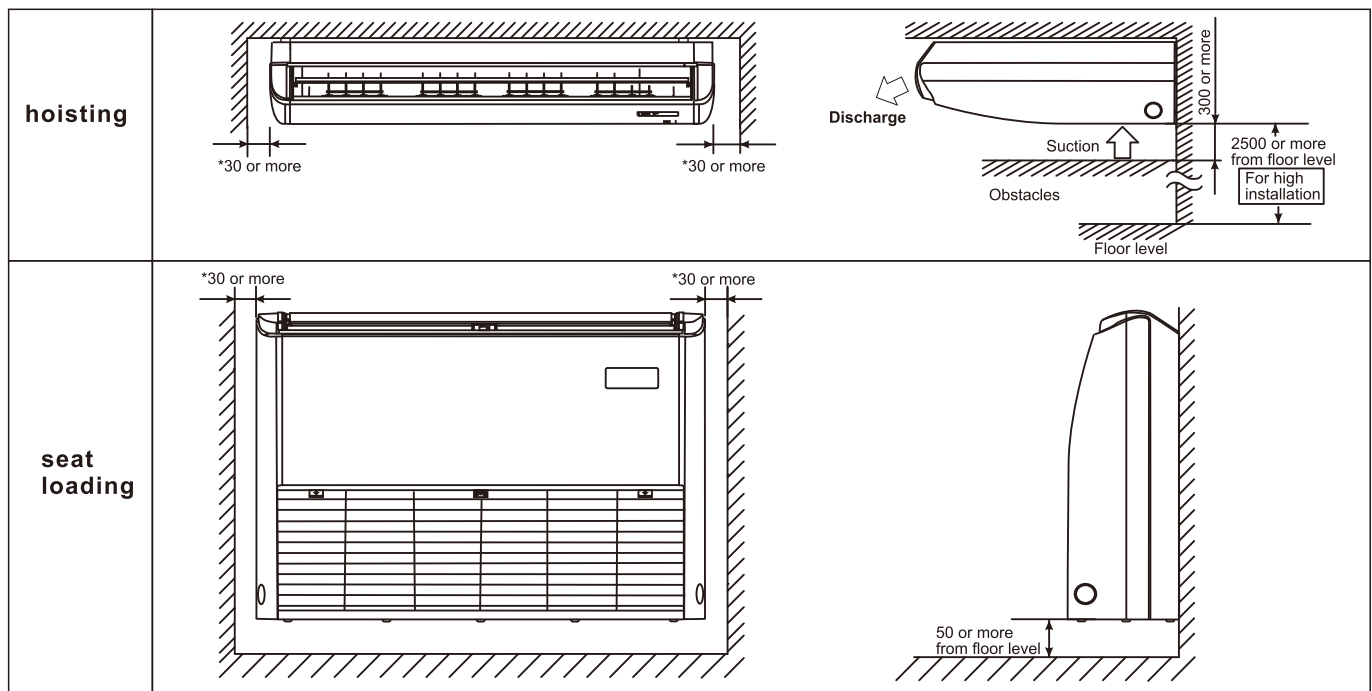

**NOTE:**

If there is extra space required for \* part, servicing can be conducted more easily. if 200mm or more is secured. Install the indoor and outdoor units, power supply wiring, remote controller wiring and signal wiring at least 1m away from televisions or radios to prevent image interference or noise.(Depending on the radio waves, a distance of 1m may not be sufficient to eliminate the noise.)

## 2. Use hanging bolts for installation

Investigate if the installation place can withstand the mass of the indoor unit and, if necessary, hang the indoor unit with bolts after it is reinforced by beams etc. (Refer to the installation pattern paper for the mounting pitch).

## 3. Ceiling height

This indoor unit can be installed up to 4.3m for packing size(1675\*770\*320mm) and up to 3.5m for other.

- Please do not take out the product and discharge horizontal blade and the air outlet.

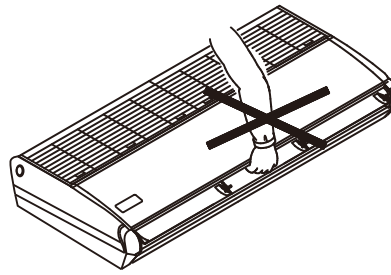
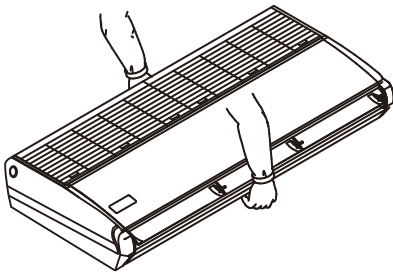

- Please do not lift the product and do not pull it with the reinforced plate (right and left). When the reinforced plate bends, it might cause noise.

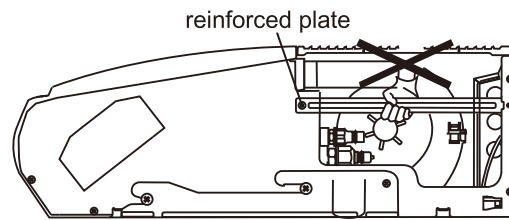
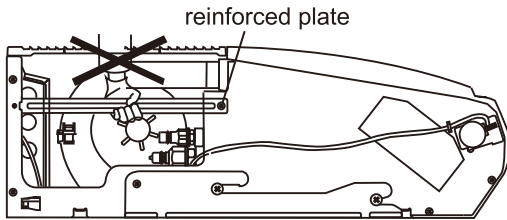

## 4. Preparation before installation or the locations of indoor unit hanging bolts, piping outlet holes, drain piping outlet hole, and electric wiring inlet hole.

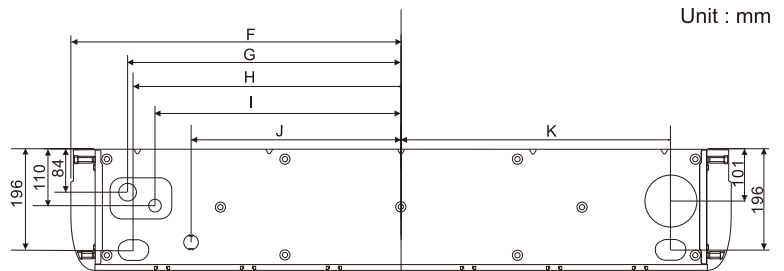
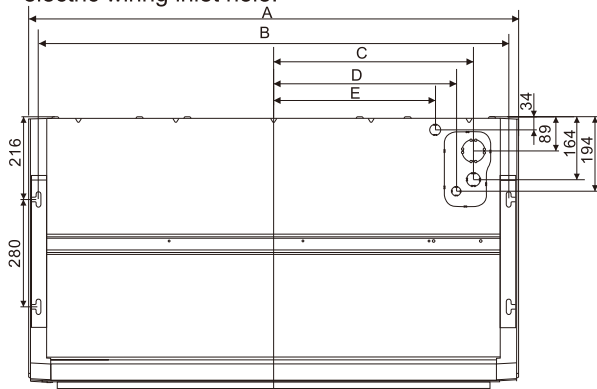

Packing Size (mm)	A	B	C	D	E	F	G	H	I	J	k
1080*770*325	1000	948	382	337	282	500	390	378	336	267	382
1360*770*325	1280	1228	522	477	422	640	530	518	476	407	522
1680*770*325	1600	1548	777	732	692	800	690	678	635	567	682

## Remove the parts of indoor unit

### 1. Remove the parts of the indoor unit.

- Remove the suction grille.
- Slide the suction grille fixing knobs toward backward direction (as shown by an arrow) to open the suction grille widely.
- Keeping the suction grille opened, hold the knob at the back of the suction grille and at the same time, pull the suction grille forward to remove.
- After removing the grille, screw in the lower cover screws as shown. Remove the end cover in the direction of arrow. (The left and right end covers are symmetrical.)

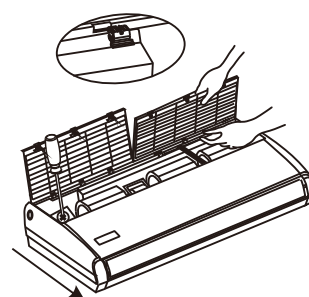
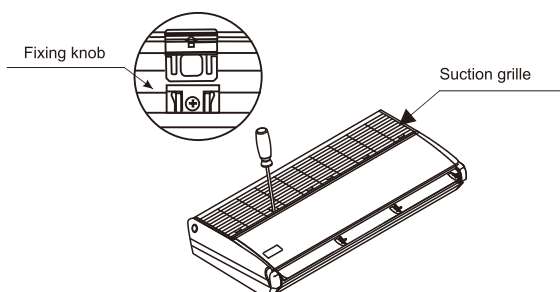

## 2.Remove the hanger

- Loosen 2 bolts for installing the hanger at both sides (M8) (4 places at left and right) within 10mm.
- Remove the fixture screw for hanger at the back side (M5), pull the hanger backward (the arrow direction) to remove.

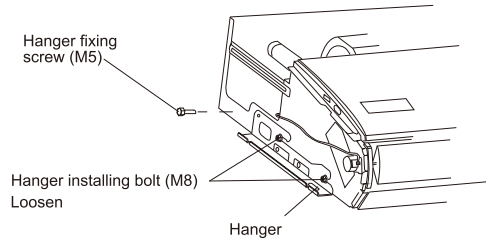
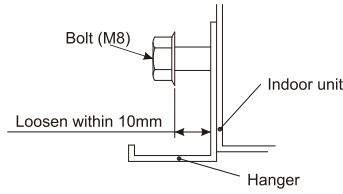

## 3.Installation of the indoor unit

- Lift up the indoor unit, slide from the front and put the hanger installing bolt (M8) into the securely for temporary hanger.
- Tighten the hanger fixing screws (M5) at 2 places, which were removed, as they were before. It is necessary to prevent misalignment of the indoor unit.
- Tighten the hanger installing bolts (M8) at 4 places properly.

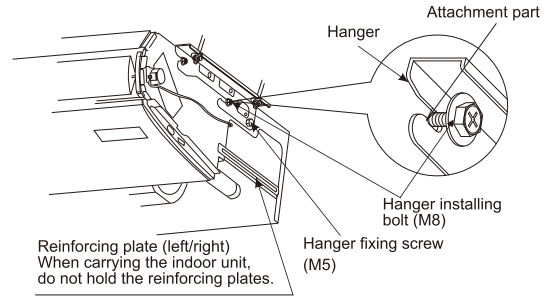

## Ceiling installation

### 1.Select the suspension foundation

The suspension foundation is a structure of either wooden frame or reinforced concrete. It must be firm and reliable to bear the weight of more than 200kg and capable of bearing vibration for long periods.

### 2.Fixing of suspension foundation

Fix the suspension foundation bolts either as shown on the right or by a steel or wooden bracket.

### 3.The suspension of indoor unit

the indoor unit should be suspension as shown below:

- Adjust the relative positions of the suspension hooks.
- Tighten the nuts and ensure that the hooks are tightly connected to the nuts and shims.
- After the unit is installed ensure it is secure and does not shake or sway

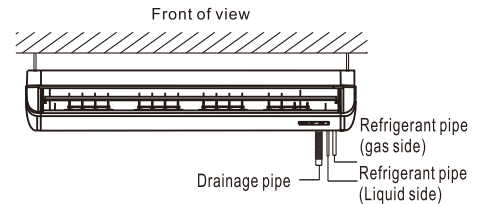
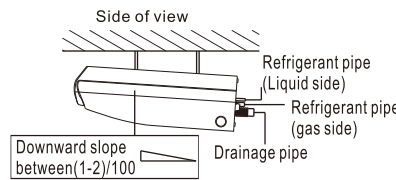
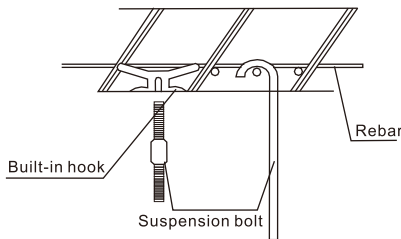

## Caution

- 1.In order to ensure the drainage water come out successfully, the unit must be declined to the bottom side of unit when finished installation.
- 2.Please make sure the front side higher, otherwise it may cause drainage come out from the air outlet.

### 4.Installation of drainage pipe

- ①The drain pipe should be properly insulated to prevent the generation of condensation.
- ②Pipes it should be installed with a downward gradient to allow the water to drain away.
- ③The pipe should not rise at any point.



## Wall-Mounted installation

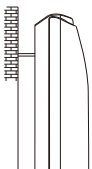

## Caution

The unit must be horizontal or declined to drain hose when finished installation.

# Installation of indoor unit----- Ceiling & Floor Air Conditioner Unit (Type 2)

## Select installation site

### 1. Ceiling installation

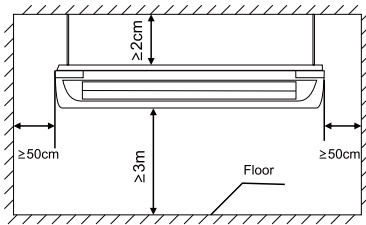

### 2. Wall-Mounted installation

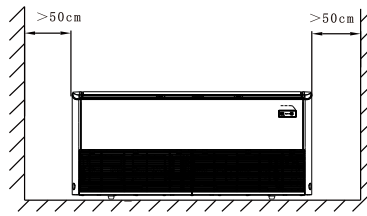

## The dimension of indoor unit

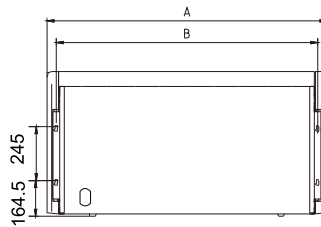
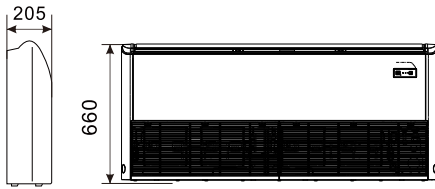

Packing Size (cm)	A mm	B mm
101*72.5*29	930	841
136*72.5*29	1280	1192
171*72.5*29	1630	1543

## Ceiling installation

### 1. Select the suspension foundation

The suspension foundation is a structure of either wooden frame or reinforced concrete. It must be firm and reliable to bear the weight of more than 200kg and capable of bearing vibration for long periods.

### 2. Fixing of suspension foundation

Fix the suspension foundation bolts either as shown on the right or by a steel or wooden bracket.

### 3. The suspension of indoor unit

the indoor unit should be suspension as shown below:

- ① Adjust the relative positions of the suspension hooks .
- ② Tighten the nuts and ensure that the hooks are tightly connected to the nuts and shims.
- ③ After the unit is installed ensure it is secure and does not shake or sway.

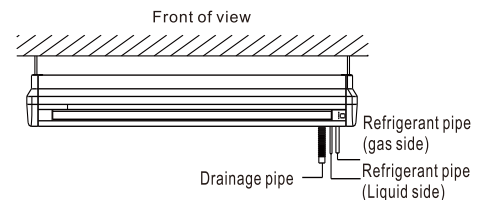
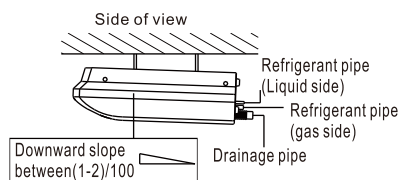
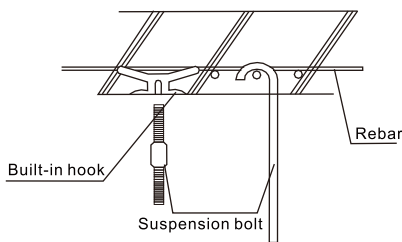

## ⚠ Caution

1. In order to ensure the drainage water come out successfully, the unit must be declined to the bottom side of unit when finished installation.
2. Please make sure the front side higher, otherwise it may cause drainage come out from the air outlet.

### 4. Installation of drainage pipe

- ① The drain pipe should be properly insulated to prevent the generation of condensation.
- ② Pipes it should be installed with a downward gradient to allow the water to drain away.
- ③ The pipe should not rise at any point.

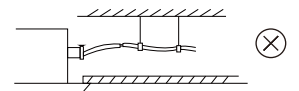
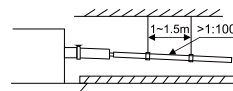

## Wall-Mounted installation

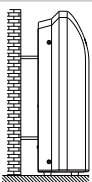

## ⚠ Caution

The unit must be horizontal or declined to drain hose when finished installation.

# Installation of outdoor unit

## Outdoor unit Dimensions

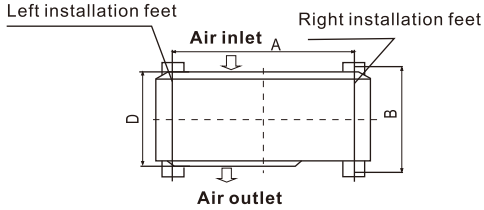
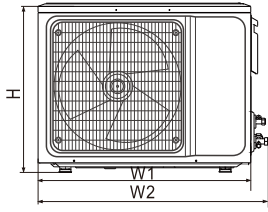

Outdoor Unit Size of Shape W1(W2)*H*D (mm)	A mm	B mm
709(761)×536×280	480	283
730(780)×545×285	540	280
785(845)×550×295	485	280
785(845)×555×300	546	316
800(860)×545×315	545	315
825(880)×655×310	540	335
900(950)×700×350	630	350
970(1045)×803×395	675	410
940(1010)×1325×370	625	364
940(1008)×1366×401	610	388

## Select installation site

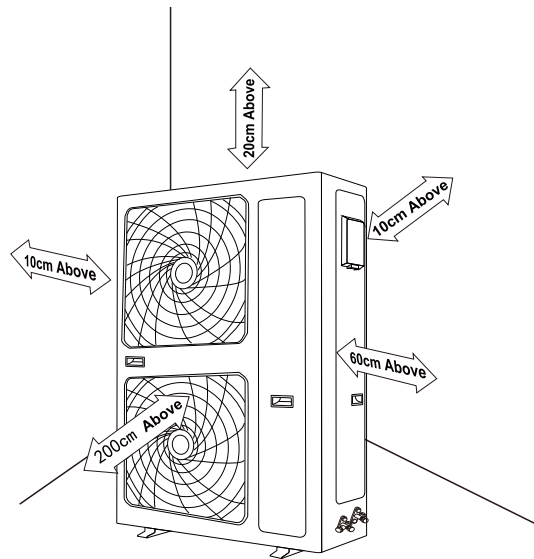
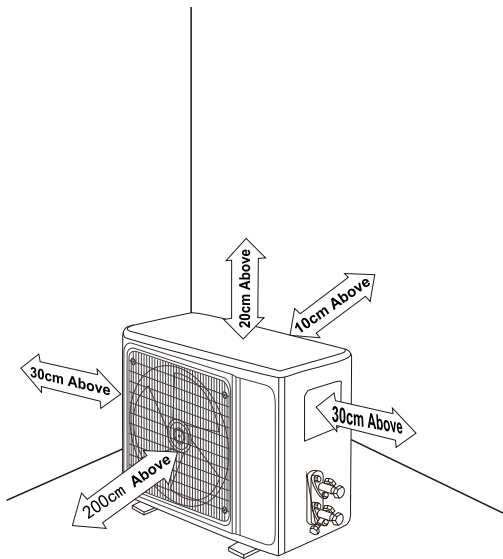

- Where you site the outdoor unit will have a direct affect upon its performance. In order for the outdoor unit to operate at its best you should carefully follow these instructions. In particular"short cycling"(allowing discharge air to return to the rear of the unit) should be avoided as this will significantly reduce the cooling and heating performance.
  1. The discharge air which is expelled from the front of the unit should not be allowed to short cycle and return back to the unit.
  2. Ensure there is ample space around the unit for service and maintenance.
  3. Ensure the unit is installed on the level. Do not allow a slope of more than 5°.
- The following figures show the right installation and wrong installation:

Wrong installation			
Right installation			

### ⚠ Caution

1. The installation place must be well-ventilated, so that the unit can be move enough air to operate correctly.
2. The installation place must be enough firm to support the weight of outdoor unit and can isolate noise and vibration.
3. Avoid direct sunlight, and if necessary a sun shelter should be mounted.
4. The installation place should allow for the drainage or rainwater and water produced during defrosting.
5. The installation place should prevent the unit from getting buried in a snow drift.
6. The unit should not be installed so that the fan blows into strong winds.
7. Ensure that neither the air from the outdoor unit nor noise produced by it will affect the neighbours.
8. The unit must not be in a position where people will pile rubbish onto it or where it will be affected by exhaust gases.

### ⚠ Warning

If the outdoor unit runs in an atmospheric environment where there are oil sources (including machine oil), salts (marine areas), and sulphide gas (near hot springs or oil refineries), these substances may cause unit faults.

### Installation

1. Install a drainage channel to allow the condensate to flow smoothly away.
2. During installation please ensure that the foundations are secure and level to avoid vibration and noise.
3. Please bolt the outdoor unit down securely.
4. The bolts for connecting the outdoor unit should protrude 20mm above the surface of the base.
5. Do not just use the four corners as a foundation to support the unit.



### ⚠ Caution

Please install a drainage channel around the foundations to drain away condensate when the outdoor unit is installed on a roof please ensure that it is solid enough to bear the weight of the outdoor unit, that the installation will not affect its water tightness and condensate is able to drain away freely.

### Installation guide at the seaside

1. Air conditioners should not be installed in areas where corrosive gases, such as acid alkaline gas, are produced.
2. Do not install the product where it could be exposed to sea wind (salty wind) directly. It can result in corrosion on the product. Corrosion, particularly on the condenser and evaporator fins, could cause product malfunction or inefficient performance.
3. If the outdoor unit is installed close to the seaside, it should avoid direct exposure to the sea wind. Otherwise it needs additional anticorrosion treatment on the heat exchanger.
4. Select a well-drained place.

#### ● Selecting the location (outdoor unit)

Install the outdoor unit on the opposite side of the sea wind direction, or set up a windbreak to avoid exposure to the sea wind.

- The windbreak should be strong enough like concrete to prevent the sea wind from the sea. The height  $\geq 70\text{cm}$  and width should be more than 150% of the outdoor unit.

- It should be kept more than 70 cm of space between the outdoor unit and the windbreak for easy air flow.

Periodic (more than once/year) cleaning of the dust or salt particles stuck on the heat exchanger by using water.

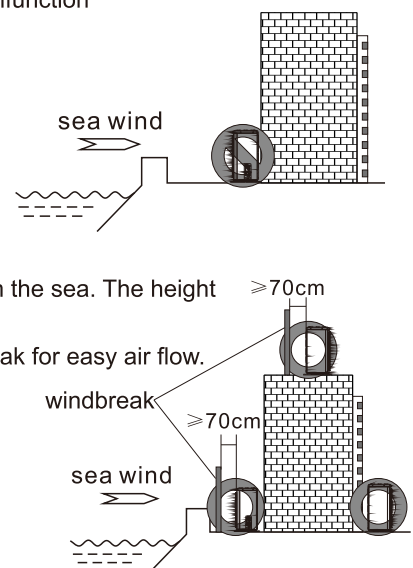

# Installation of tubing

## Installation instructions

1. Ensure the following when long pipe work is required and this is to be brazed.
  - a) Please fully install the tubing and any brazing work before connecting the pipes to the unit.
  - b) Oxygen Free Nitrogen must be used inside the pipes to prevent oxidation.
2. If there are many joints requiring brazing during the installation of long tubing, please use an in line filter. All tubes must use refrigeration quality dehydrated copper pipe and not normal plumbing copper and should be free from moisture, dust or other contaminants.
3. Please purge the pipe with nitrogen or to eliminate any dust inside before oxidation.
4. Please install the pipeline according to the pipe direction, and don't repeatedly bend and then straighten a piece of pipe more than 3 times (this will damage the copper). Please use a pipe bender to bend the pipe. After preparing a length of pipe slide pipe insulation material over it.
5. After the connecting pipe work has been completed, connect to the indoor unit using the flare connector provided. Disconnect the flare nut from the indoor unit valve and place over the pipe facing the indoor unit. Flare the pipe as shown in this manual, and after coating both the flare nut and both inside and outside of the flare with a light coat of refrigerant oil, tighten the nut using a torque wrench to tighten the nut and a spanner to hold the valve on the unit. Always use a torque wrench set to the correct torque and always hold the indoor unit valve steady with another spanner. Do not under or over tighten. This process is carried out for both the small and large pipes.
6. Connect to the outdoor unit in a similar manner.
7. After the connection of tubing is completed, please carry out a full leak test on the pipe work and ensure the pipe work and connections do not leak and everything is fully insulated.

## Heat insulation and sealing

### Caution

Copper tube and drain pipe must be separately insulated to prevent condensation or water leakage.

1. The copper tube should be properly insulated using materials designed for insulating air conditioner pipe and heat resistive above 120°C.

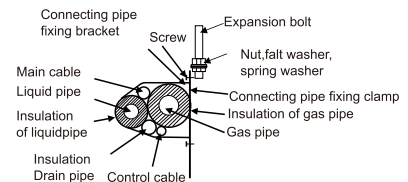

2. Matters requiring attention in areas with very high humidity level:

The air conditioner has been fully tested in various humidity conditions. However, if it runs for long periods of time in a high humidity environment so water drops will arise. The following heat insulation material should be carried out.

- a) The indoor unit should be externally insulated using 10-20mm thickness glass fibre.
- b) The normal pipe insulation is around 8mm for tubing.

3. Sealing the wall:

To prevent rainwater or other foreign bodies from entering the room and air conditioner after installing the tubing and drain pipe, the gap between wall hole and tubing, drain pipe and electric wire should be sealed with mastic, sealant rubber or putty, or poor performance or leakage will result. If the outdoor unit is higher than indoor unit, tubing should be bent to ensure that the lowest point of the tubing is lower than the wall hole to prevent rainwater entering the room or air conditioner along the piping system.

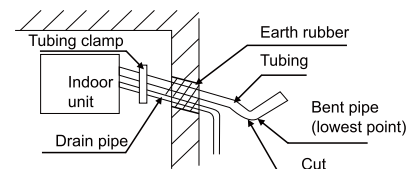

Make a cut in the heat insulation materials of bent pipe (for drainage)

4. The connection of air outlet needs insulating.

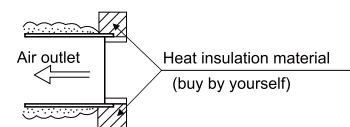

5. The pipes of air outlet are connected under insulating.

## Connection of refrigerant pipe

The standard refrigerant pipe length is 5m long. If the distance between the indoor and outdoor is longer is longer than this, then the pipe needs to be extended.

Please refer to the following table for the limitations of each unit as far as maximum distance and height.

Do not exceed these limits or compressor failure may result.

Keep the pipe separation length and the number of bends to the lowest possibility and always follow the shortest path for the pipe installation.

As the pipe length and number of bends increases the performance of the unit decreases and energy use increases.

Specification Model	Connecting pipe dim. (φmm)		Max.Connecting pipe & length			Max. Difference In Level(m)	Max.Bending number
	Liquid pipe	Gas pipe	liquid pipe	Gas pipe	Max. Length(m)		
12000BTU	6.35	12.7	7.94	15.88	25	10	3
18000BTU	6.35	12.7	7.94	15.88	30	20	5
24000BTU	6.35/9.52	12.7/15.88	6.35/9.52	15.88/19.05	50	25	8
30000BTU	9.52	15.88	9.52	19.05	50	25	8
36000BTU	9.52	15.88	9.52	19.05	65	30	8
42000BTU	9.52	15.88/19.05	9.52/12.7	19.05/22.2	65	30	8
48000BTU	9.52	15.88/19.05	12.7	19.05/22.2	65	30	10
60000BTU	9.52	15.88/19.05	12.7	19.05/22.2	65	30	10

● Only refrigeration quality, deoxidized, seamless, phosphor copper tube suitable for R410a should be used as a refrigerant pipe.

### ● Requirements for connecting pipe between indoor unit and outdoor unit:

- 1.Machining dimension of flared pipe section is as shown in following table;
- 2.When flaring nut is connected, some refrigerant oil should be applied on the flared pipe section (both inside wall and outside wall), and screw the nut by 3-4 thread pitches before finally tightening it;
- 3.Tightening torque is shown in the following table;
- 4.Carry out leakage test after the completion of the installation.

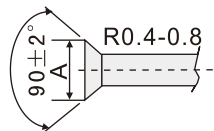
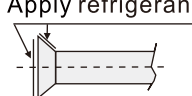
Tube specification (mm)	Tightening torque (N•m)	Machining dimension of flared pipe section(mm)	Shape of flared mouth	Apply refrigerant oil
φ6.35	15-19	8.3-8.7		
φ9.52	35-40	12.0-12.4		
φ12.7	50-60	15.4-15.8		
φ15.88	62-76	18.6-19.0		
φ19.05	98-120	22.9-23.3		

### ● Precautions to prevent compressor oil return defect

- 1.Horizontal pipes should incline toward the outdoor unit using a 20:1 slope.
- 2.If there is a height difference between the indoor and outdoor unit, oil traps should be installed in the interconnecting gas (large) pipe:  
When the vertical pipe height difference is less than 5 meters, an oil trap should be installed at the bottom of the gas(large) pipe. When the vertical pipe height difference is more than 5 meters, then for every 5 meters an oil trap must be installed at the bottom of the gas(large)pipe, and a short loop (liquid ring) should be installed at the exit of the indoor unit liquid(small) pipe:  
When the connecting gas pipe vertical height difference is less than 5 meters but the constant rise distance is too long, an oil trap should be installed in the gas(large)pipe every 10 meters.
- 3.When the outdoor and indoor units are at the same elevation, the oil deposit bend and liquid ring do not need to be installed, if the horizontal connecting pipe length is less than 10meters. When the horizontal connecting pipe length is more than 10 meters, install an oil trap in the gas(large) pipe every 10meters.

Note: This chart is for explanation purposes. An actual installation maybe different from this and it should consider the site conditions. When making an oil trap the radius of the bend should be between 1.5 and 2 times the pipe diameter.

When the installation position of indoor unit is higher than that of the outdoor unit.

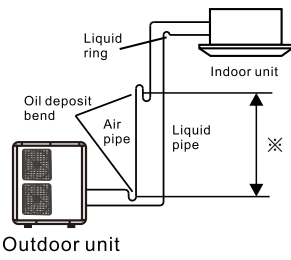

When the installation position of indoor unit is lower than that of the outdoor unit.

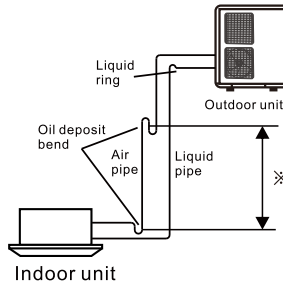

※means that each height difference sets an oil deposit bend

Model	Difference of Height
12000BTU	6m
18000BTU	
24000BTU	
30000BTU	10m
36000BTU	
42000BTU	
48000BTU	
60000BTU	

### ● Connection of tubing and indoor unit

Remove the copper nut from indoor unit and insert it over the unflared tube before making the flare, align the flaring side of the connecting pipe with the connector of indoor unit, lightly coat the flare and nut with refrigerant oil, screw the copper nut onto the connector of indoor unit and tighten it (tightening torque is shown in the table above).

### ● Connection of tubing and outdoor unit

Follow the instructions for flaring the indoor unit as Fig:

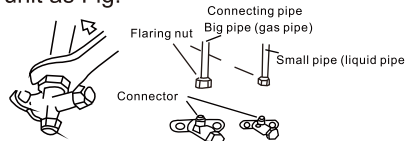

## Installation of drainage pipe

### ⚠ Warning

In order to ensure the drainage water come out successfully, the unit must be declined to the bottom side of unit when finished installation.

1. The drainage pipe must be wrapped by thermal insulations to properly insulated to prevent the generation of freezing.
2. The pipe should be installed with a downward gradient ( $> 1/1.36$ ) to allow the water to drain away.
3. The pipe should not rise at any point.

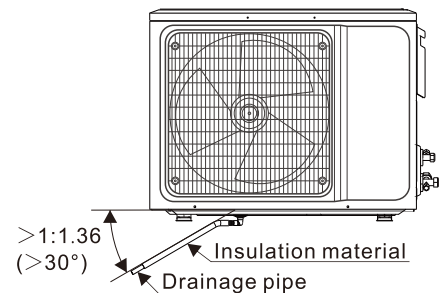

## Evacuating or purging the pipe work

Before releasing the refrigerant in the outdoor unit into the pipe work and indoor unit it is necessary to ensure that there are no foreign objects, water or non-condensing gas in the refrigeration system. For that purpose, it is necessary to evacuate or purge the system:

### ★ Exclusive R32 refrigerant pump must be used in making R32 refrigerant vacuum.

Before working on the air conditioner, remove the cover of the stop valve (gas and liquid valves) and be sure to retighten it afterward. (to prevent the potential air leakage)

1. To prevent air leakage and spilling tighten all connecting nut of all flare tubes.
2. Connect the stop valve, charge hose, manifold valve, and vacuum pump.
3. Fully open the handle Lo of the manifold valve and apply vacuum for at least 15 minutes and check that the compound vacuum gauge reads  $-0.1\text{MPa}(-76\text{cmHg})$ .  
If the gauge does not read  $-0.1\text{MPa}(-76\text{cmHg})$  after 15 minutes, it should be pumped 5 minutes more. If the pressure can't achieve  $-0.1\text{MPa}(-76\text{cmHg})$  after pumping 20 minutes, please check if there are some leakage points.
4. After applying vacuum, fully open the stop valve with a hex wrench.
5. Leave the gauge and pump as they are for 1 or 2 minutes, then make sure that the compound vacuum gauge reading stays at  $-0.1\text{MPa}(-76\text{cmHg})$ .

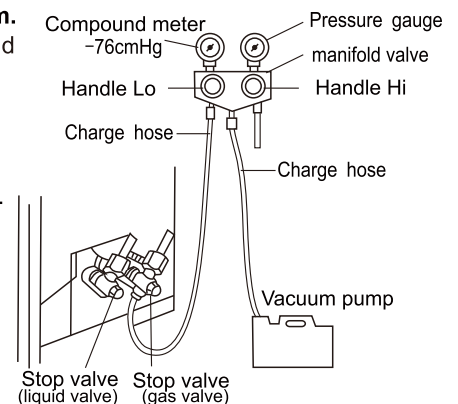

## Adjust the refrigerant quantity

When pipe length exceeds 5m, please add refrigerant according to the table below:

Refrigerant pipe	Refrigerant pipe specification		Additional fill of refrigerant(kg/m)
	Gas pipe(mm)	Liquid pipe(mm)	
Tubing between indoor unit and outdoor unit	φ9.52	φ6.35	0.03
	φ12.7	φ6.35	0.03
	φ15.88	φ9.52	0.05
	φ19.05	φ9.52	0.05

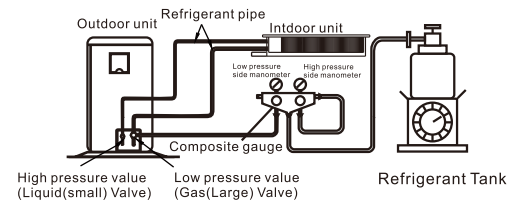

Note:

1. This table is for reference only.
2. The joints shall not be reused, unless after re-flaring the pipe.
3. After installation, check the stop valve whether be fixed effectively.
4. The thickness of the pipe is 0.6-1.0, bearing pressure is 4.2MPa.
5. If the connection pipe is too long, the cooling capacity and stability would be decreased. And the more bend quantity, the resistance in the piping system would be bigger, then the cooling and heating capacity would be decreased even lead to compressor broken. We suggest you to use the shortest connection pipe according to the pipe length parameter in this manual.
6. Please add refrigerant according to liquid pipe.

## Electrical connections

### Warning

- All electrical works must be carried out & checked by a qualified electrician and must adhere to the IET regulations, local and national legislation and industry best practice. The system must have its own independent power supply. An all pole isolating disconnect switch with at least 3mm contact separation must be installed. The power cord and connecting cable should be either as supplied with the unit or otherwise as specified in this manual.
- Do not attempt any electrical works yourself.
- An Earth Leakage Protector, Power Switch and Circuit Breaker or Fuse must be installed in the dedicated power supply or there is the risk of electric shock.
- The fuse specification of single-phase control panel is F5AL 250V;  
The fuse specification of three-phase control panel is F3.15AL 250V.
- The grounding must be reliable. If grounding is not correct, it may lead to electric shock.
- All power cables should be properly secured with cable ties so that external forces cannot disconnect the wired from the terminals. Improper connections or insecure fastening can cause electric shocks or fire.

### Caution

- Do not connect the earth cable to gas or water pipes, telephone lines, lightning rods or the earth cables of other products.
- Once the indoor and outdoor unit have been switched on, do not cut off power off power supply in 1 minute, (the system automatically set) otherwise abnormal operation will be caused.

- Please connect the power cord and interconnecting cable according to the wiring diagram.
- Connect the wire firmly to the terminal block using crimps and secure in order to prevent external forces pulling on the wire causing risk of fire or electric shock.
- After the electrical connection is completed, all wires should be prevented from touching other parts such as tubing, compressor etc.

## ⚠ Caution

1. The definition of power cord is the power supply cable from the isolating switch attached to the dedicated power supply to the indoor unit or outdoor unit. Interconnecting cable for the indoor and outdoor unit is the power cable that connects indoor unit and outdoor unit.
2. Above-mentioned definitions are the specifications of power supply, power cord and interconnecting cable of indoor unit and outdoor unit of all different types of air conditioners.
3. To avoid voltage drops, when the cross sectional area of a power cable core reaches the minimum size, and the power cord is lengthened, you should choose another bigger power cable size.
4. The power cord connected to the indoor unit is 227 IEC53 type cable. The power cord connected to outdoor unit and the interconnecting cable between indoor unit and outdoor unit are both H05RN-F (neoprene) stranded wire. If you use single-strand two ply wire, please select wire with larger cross-section area by one size and a special electric jacket should be used.

### Selection of electrical parts

- The Interconnection cord connect the indoor and outdoor units. You must first choose the right cable size before preparing it for connection.
- Minimum Cross-Sectional Area of Power Cable and interconnection cord.

#### North America

Appliance Amps (A)	AWG
10	18
13	16
18	14
25	12
30	10
40	8

#### Other Regions

Rated Current of Appliance (A)	Nominal Cross-Sectional Area (mm <sup>2</sup> )
> 3 and ≤ 6	0.75
> 6 and ≤ 10	1
> 10 and ≤ 16	1.5
> 16 and ≤ 25	2.5
> 25 and ≤ 32	4
> 32 and ≤ 40	6

- The size of the interconnection cord, power cable, fuse, and switch needed is determined by the maximum current of the unit. The maximum current is indicated on the nameplate located on the side panel of the unit. Refer to this nameplate to choose the right cable, fuse, or switch.
- Note: Core number of cable refer to the detailed wiring diagram adhered on the unit which you purchased.

### Magnetic ring installation instructions

- **A magnetic ring in the accessory bag:**
  1. **If the machine is equipped with a wire controller:**  
the communication line on the side of the wire controller must be wound five times by the magnetic ring.
  2. **If the model is not equipped with a wire controller:**  
the indoor power line L and N must be wound three times with the magnetic ring.
- **Two magnetic rings in the accessory bag:**  
one magnetic ring must be wound five times for the communication line on the wire controller side, and another magnetic ring must be wound three times for the indoor power line L and N.
- **Three magnetic rings in the accessory bag:**  
one magnetic ring must be wound five times for the communication line on the wire controller side, the indoor power line L and N must be wound by another magnetic ring for three times, and the outdoor power line L and N must be wound by another magnetic ring for two times.
- **Note: The wire controller communication wire must use shielded twisted pair wire.**

# Wiring of indoor unit and outdoor unit

1. Some of indoor and outdoor unit have L\N grounding terminals, which can be supplied separately by indoor and outdoor units power, Recommending outdoor unit power supply
2. The schematic diagram in the instruction manual is for reference only, it is specific to the object on the units.

## Constant speed-Heat pump type

### ●12000/18000BTU (Single-phase)

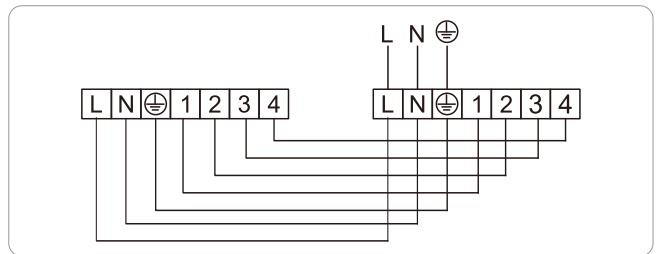
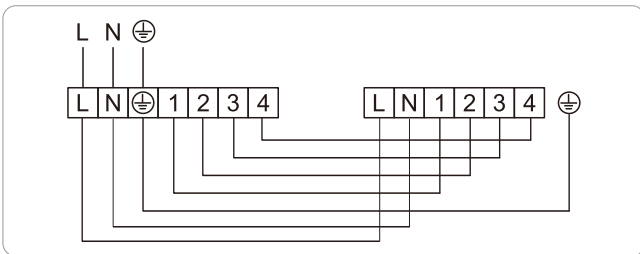
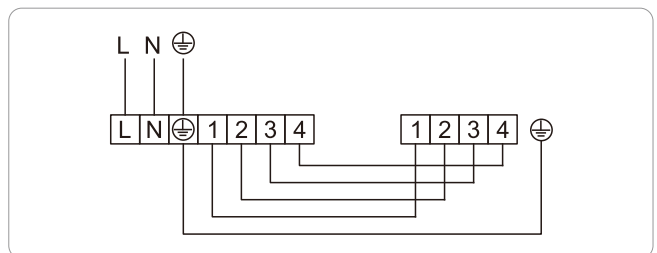
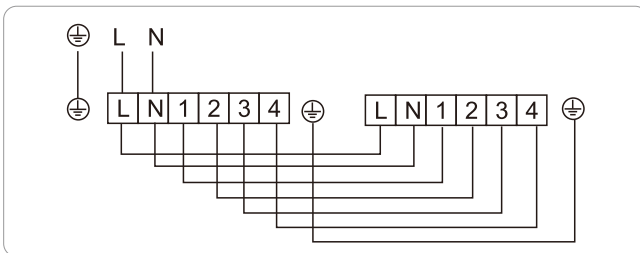
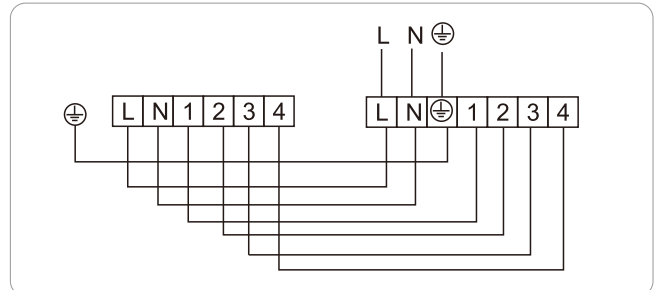
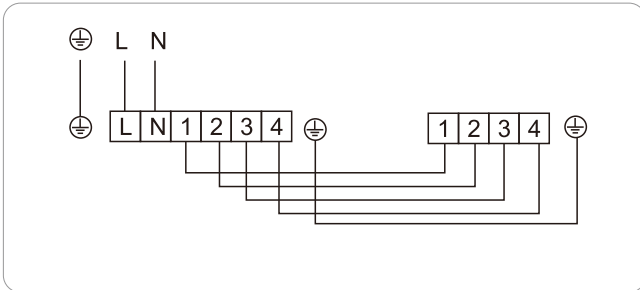

### ●24000/30000BTU (Single-phase)

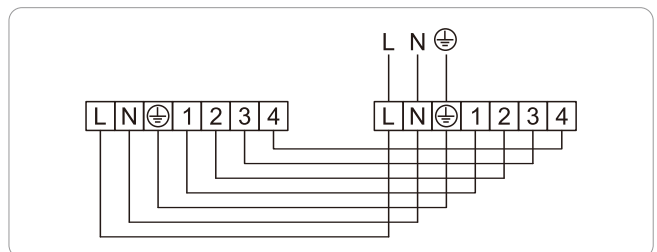
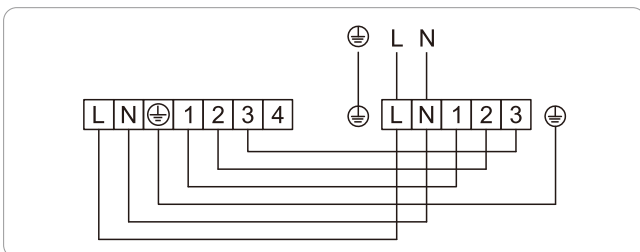
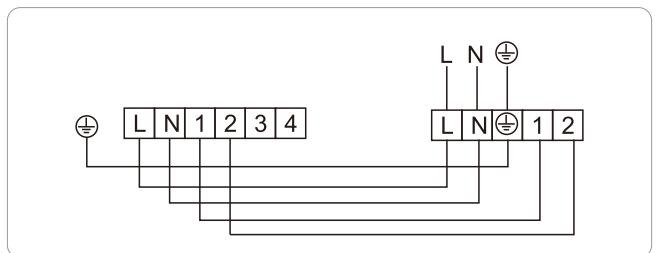
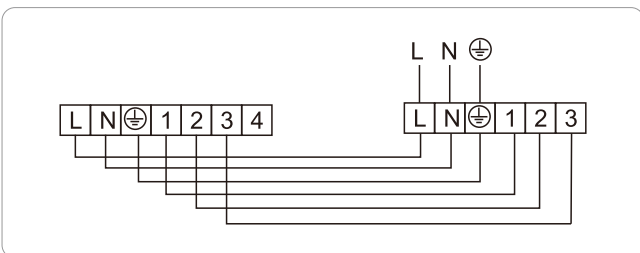
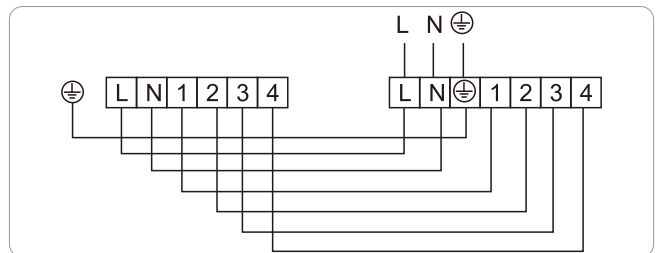
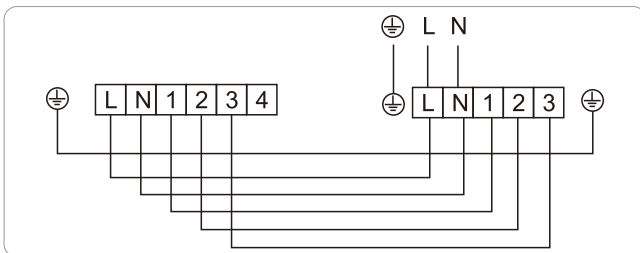

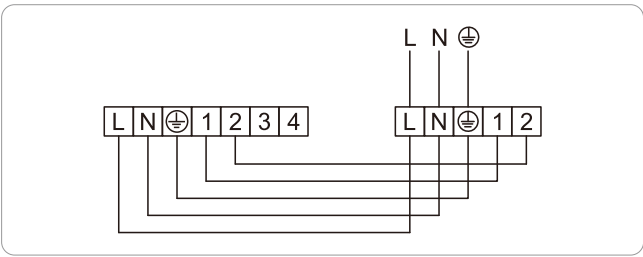

●36000BTU (Single-phase)

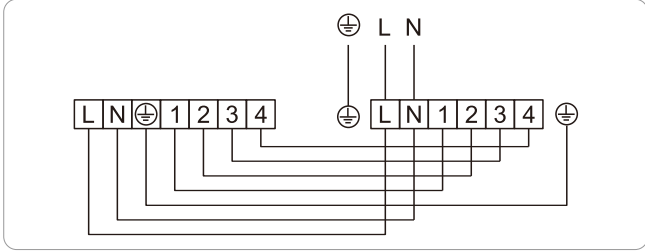
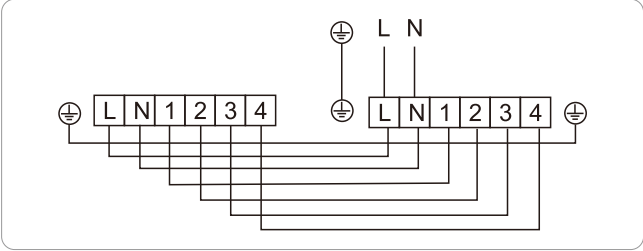
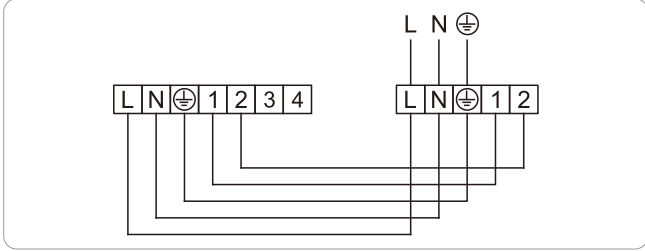
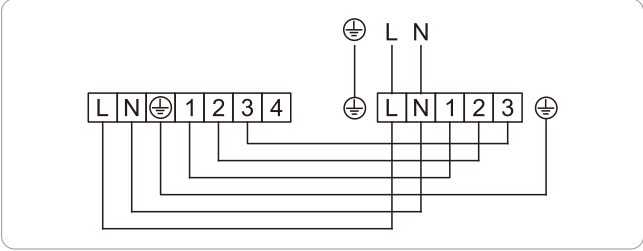
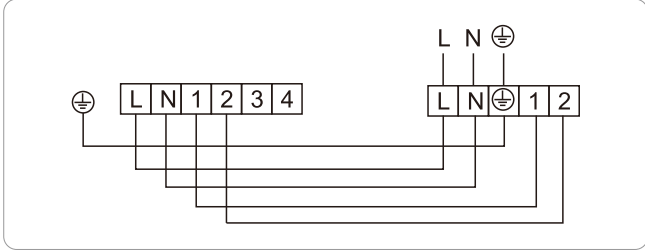
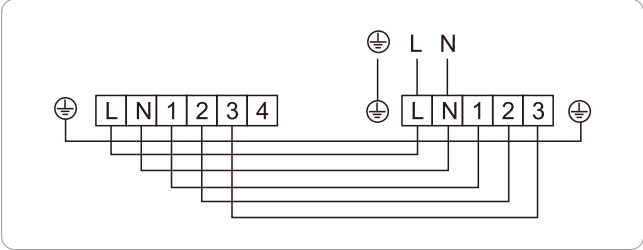

●48000/60000BTU (Single-phase)

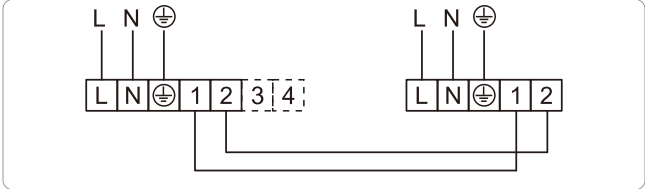
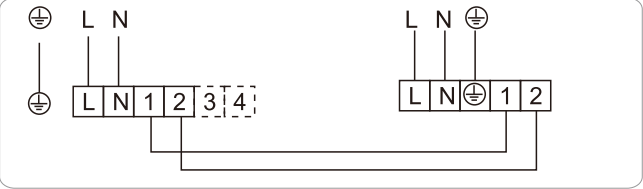

●36000/48000/60000BTU ( Three-phase )

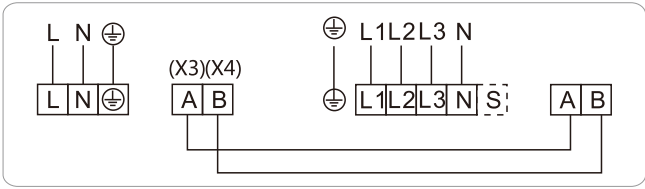
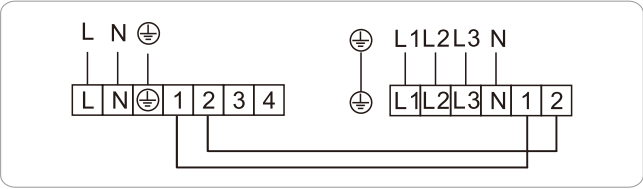
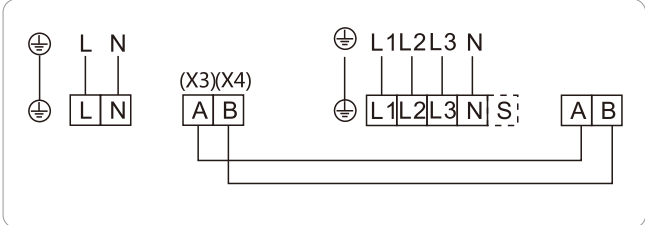
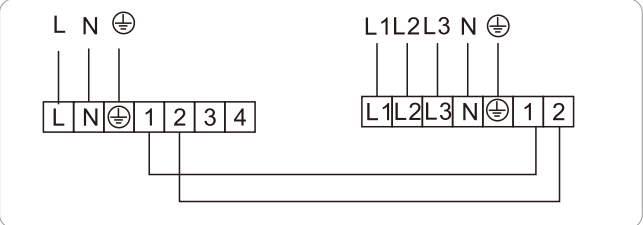
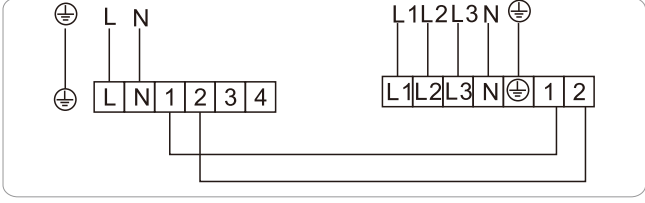
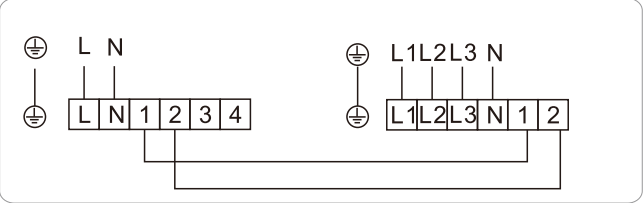

## Constant speed-Cooling Only

- 3600/4200/4800/6000BTU(Three-phase)

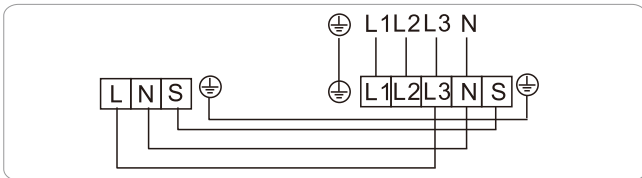

- 12000/18000BTU (Single-phase)

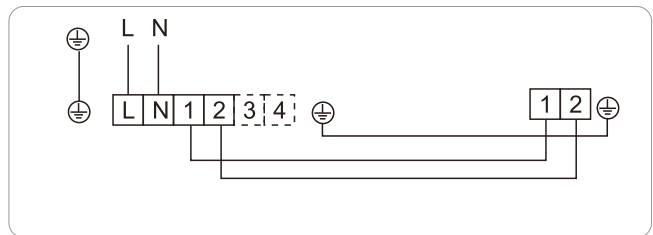
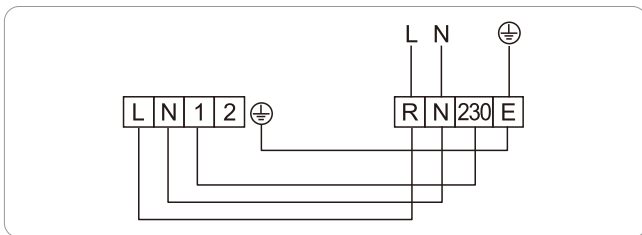
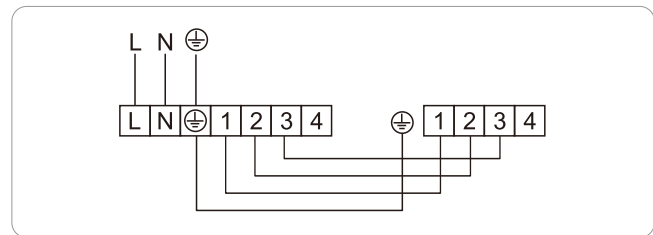
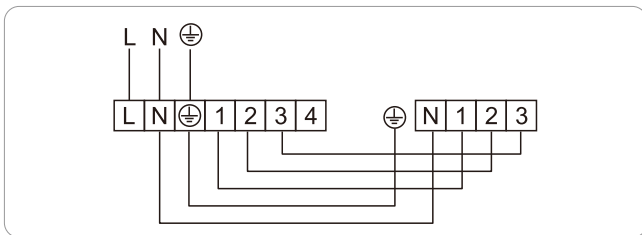
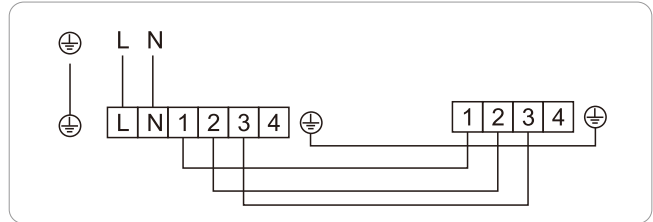
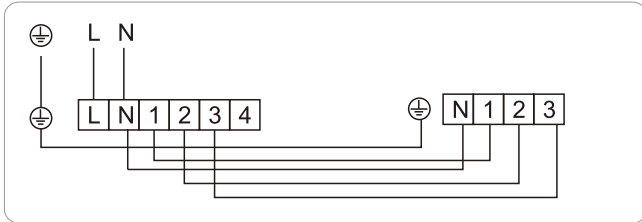

- 24000/30000BTU (Single-phase)

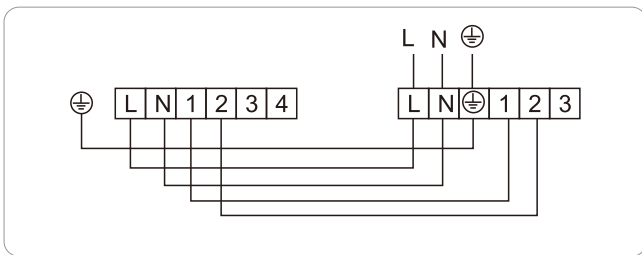

- 36000BTU (Single-phase)

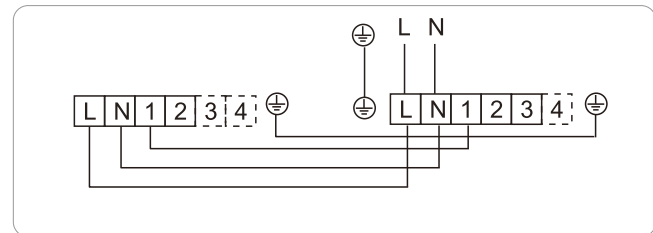
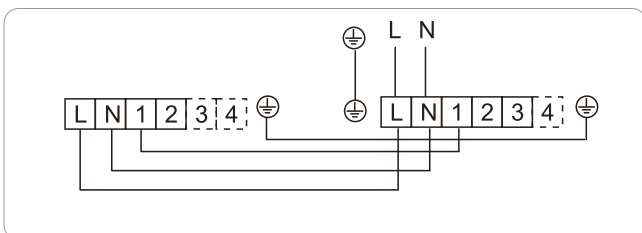
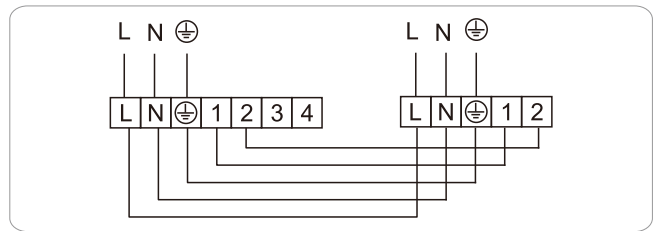
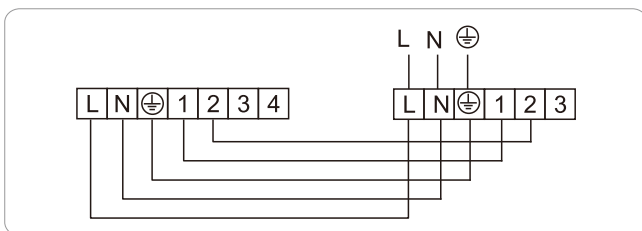
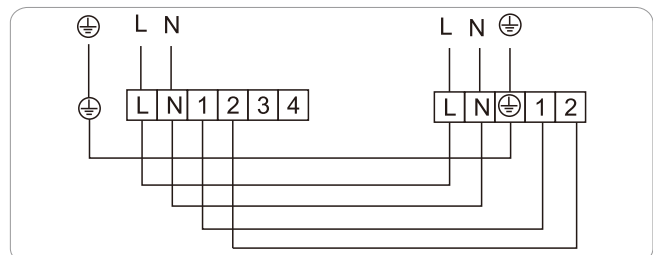

# Variable speed

## ●12000-60000BTU (Single-phase)

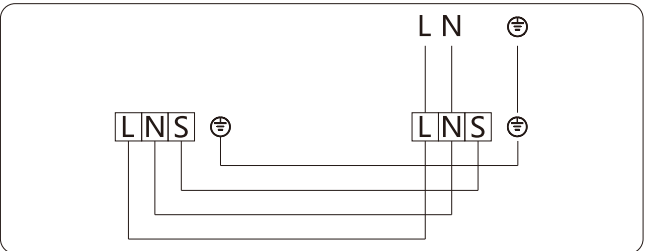
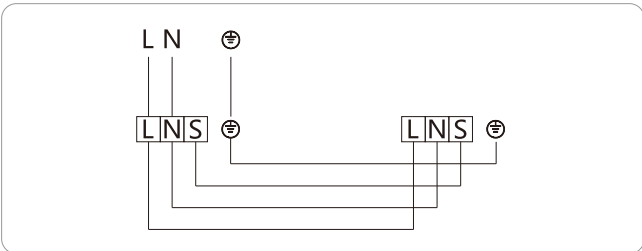
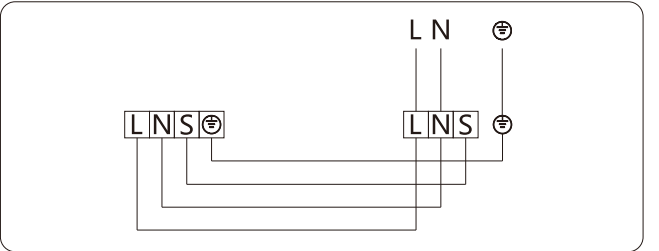
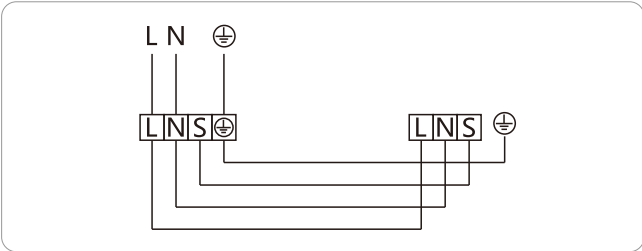
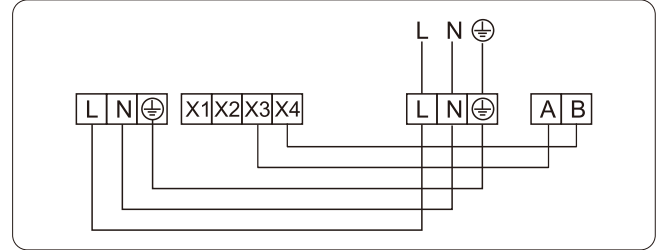
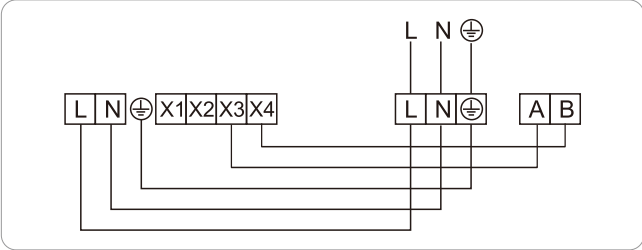
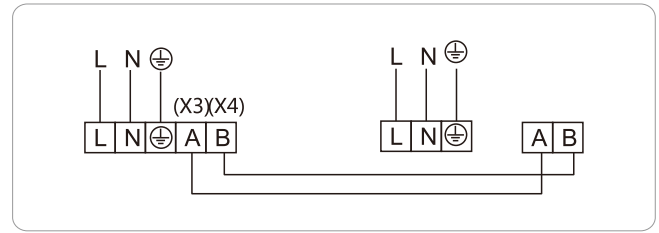
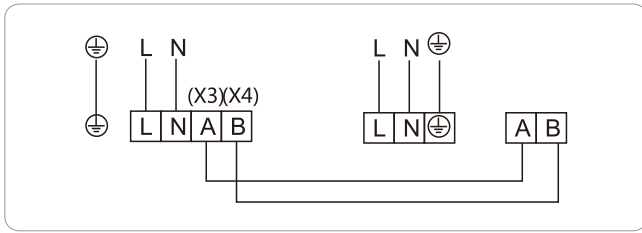

## ●18000-60000BTU(Three-phase )

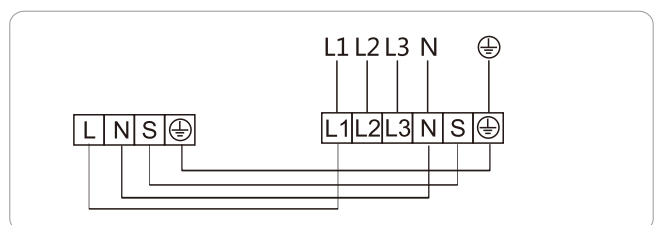
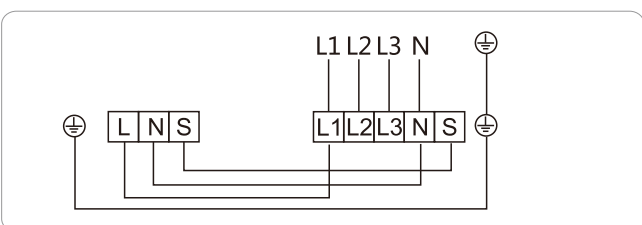
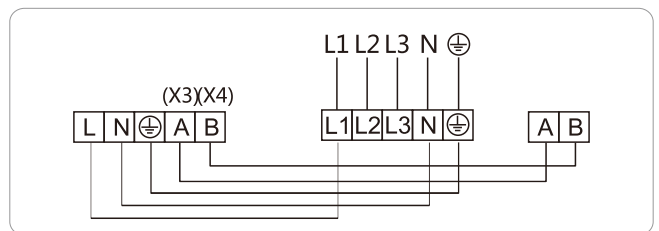
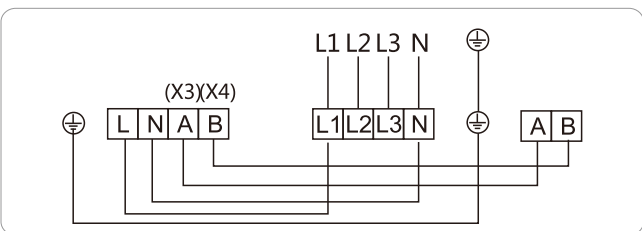
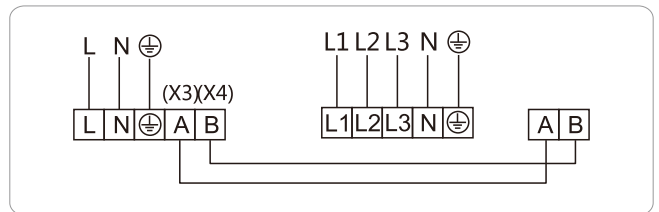
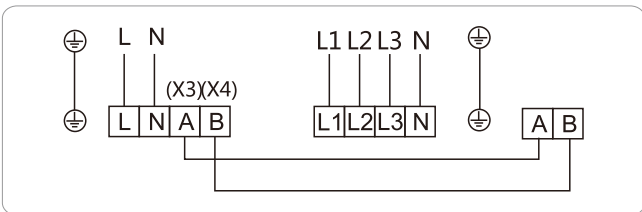

## Connection method

### To connect the indoor unit

Open the cover of terminal box cover. Connect the cables according to the electric connection diagram. And check all cables are connected safely, securely and correctly.

### To connect the outdoor

Open the outdoor unit electrical access panel and connect cables according to the circuit diagram on the backside of the access panel. And check all cables are connected safely, securely and correctly. Earth wire must be connected at the right location.

Note: The PC board of outdoor unit whose power supply has phase sequence protection. Please pay attentions to it while connecting power cable.

After all connections have been made and checked, the pipe work has been leak tested and charged and the drain pipe work tested then the pipes and cables should be bound together as follows.

1. Locate the drain pipe at the bottom along with the control cable.
2. Place the insulated refrigerant pipes on top.
3. Place the mains cable on top of these.
4. Bind carefully with tape.
5. Ensure the drain pipe is not damaged.

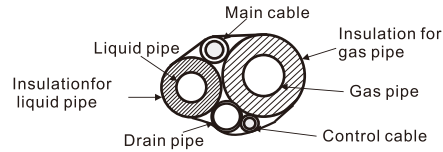

**Caution: Do not squash the drain pipe during binding operation!**

## Commissioning

### Items should be checked before Commissioning



1. Does the line match the circuit diagram?
2. When installing multiple machines at the same time, please confirm that the connection lines of the indoor and outdoor units should not be mistakenly connected.
3. Is the unit correctly grounded?
4. Is the screw loose in the wire connection ?
5. Is the insulation value more than 10MΩ ?
6. Is the pipe size correct ?
7. Is the pipe insulated material properly laid? Are the gas pipes and liquid pipes heat insulation ?
8. Are liquid side and air side cut-off valves fully open ?
9. Are the refrigerant additive charge and refrigerant pipe length recorded ?

### The steps of Commissioning

1. Turn on the Power Supply and select cooling operation as shown in the remote controller section of this manual.
2. After the 3minute compressor protection delay. Check the indoor unit louver is operating correctly and both the indoor and outdoor units are operating correctly without abnormal noise. Check that cold air is produced after a short time.
3. Select heating operation on the controller and wait for 5 minutes. Check that the indoor fan starts correctly and that hot air is produced after a short time.
4. Select Fan operation on the controller. Check that the fan operates correctly in all fan speeds.
5. Test the other functions on your controller as shown in the controller section of this manual.
6. Select Cooling operation, and check the drain pump operates correctly.
7. After confirming the unit operates correctly, turn the unit off and disconnect the power supply.

## Operation instructions

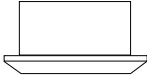
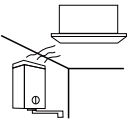
Following the instructions below will allow you to get the best from your air conditioner

Proper use method	
<p>● <b>During cooling, avoid direct sunshine</b> Please close the curtains.</p> 	<p>● <b>Do not obstruct air flow</b> Do not place objects near the air inlet or outlet of either the indoor or outdoor unit. If the air flow is obstructed then the air conditioner will be unable to perform correctly.</p>
<p>● <b>Try not to cool excessively</b> Suggestion of setting temperature. cooling: 26-28°C Dehumidify: 20-24°C</p> 	<p>● <b>Do not use other heating equipment when unit run cooling function</b> Using heating equipment will affect the cooling effect.</p> 
<p>● <b>Keep the windows or doors shut</b> Open windows or doors will increase the amount of heating or cooling the amount of heating or cooling required and may prevent the unit being able to perform correctly.</p> 	<p>● <b>Clean the air filter regularly</b> Dirty filters will prevent the unit from being able to perform correctly and may cause expensive damage. Clean regularly by washing or with a vacuum cleaner. Replace if necessary. We recommend filter cleaning once a month or more frequently if required.</p>

### ⚠ Caution

- Before cleaning the air filter stop the unit on the controller and turn off at the power supply.
- Do not clean the air conditioner with water or you risk both electric shock and short circuit.
- When cleaning the air filter ensure you pay attention to health and safety.

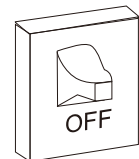

### Cleaning the air filter

In order to ensure the best performance from your air conditioner clean the air filter regularly. We recommend cleaning once a month or more frequently if required.

1. The filter can be cleaned using a vacuum cleaner or with soap and water.
2. Take off the air filter
  - ① First, take off the bolt casing on the air inlet grille, then take off the bolts using the screwdriver, and take off the filter net.
  - ② Set the filter net back to the air inlet grille, fix its bolt and the casing.

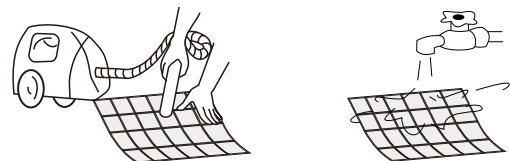

### ⚠ Caution

- Electricity, Dangerous! Cut off all the power supply before maintenance.
- When the filter is very dirty it can be washed in detergent and hot water (below 40°C).
- Ensure the filter is fully dry before reinstallation to avoid risk of electric shock or short circuiting
- Do not dry the filter using direct sunlight.

## Fault code - Variable speed

After indoor and outdoor units shut down due to failure, failure code will display on wired controller or remote receiving board. In case of normal protection, no failure code will display on wired controller or remote receiving board of indoor unit. Among others, wired controller doesn't automatically send warning, which requires pressing CHECK button to display corresponding failure codes. Remote receiving board directly displays failure codes. After failures are removed, display will automatically disappear.

Fault code	Fault description	Causes of possible failure
A1	Fault with the room temperature sensor on the indoor unit	Damage of the room temperature sensor on the indoor unit
		Poor contact of the room temperature sensor on the indoor unit
		Damage of wiring of the room temperature sensor on the indoor unit
		Damage of the main PCB on the indoor unit
A2	Fault with the temperature sensor in the middle of indoor evaporator	Damage of the temperature sensor on the indoor unit
		Poor contact of the temperature sensor on the indoor unit
		Damage of wiring of the temperature sensor on the indoor unit
		Damage of the main PCB on the indoor unit
A3	Fault with the liquid pipe temperature sensor on the indoor unit	Damage of the liquid pipe temperature sensor on the indoor unit
		Poor contact of the liquid pipe temperature sensor on the indoor unit
		Damage of wiring of the liquid pipe temperature sensor on the indoor unit
		Damage of the main PCB on the indoor unit
A4	Fault with the gas pipe temperature sensor on the indoor unit	Damage of the gas pipe temperature sensor on the indoor unit
		Poor contact of the gas pipe temperature sensor on the indoor unit
		Damage of wiring of the gas pipe temperature sensor on the indoor unit
		Damage of the main PCB on the indoor unit
A5	Fault with the drainage	Float switch disconnected or poor wiring
		Error setting of model parameters
		Drain plug
		Damage of the pump
A6	Fault with the Fan motor of indoor unit	Low voltage
		Poor wiring
		Damage of the main PCB on the indoor unit
		Damage of the motor
A8	Indoor unit EEPROM module failure	Indoor unit PCB is broken
		EEPROM module is broken.
A9	Communication error between the outdoor unit and the indoor unit	Damage of the main PCB on the indoor unit
		Damage of the main PCB on the outdoor unit
		Poor wiring
AA	Communication error between the wired controller and main PCB of the indoor unit	Poor wiring
		Damage of the wired controller
		Damage of the main PCB on the indoor unit
H1	Fault with the High pressure switch	System pipeline blockage
		Damage of the pressure switch
H4	Fault with the low pressure switch	Lack of the refrigerant
		Stop valve unopened
		Damage of the pressure switch
C1	Fault with the Environmental temperature sensor on the outdoor unit	Damage of the Environmental temperature sensor on the outdoor unit
		Poor contact of the Environmental temperature sensor on the outdoor unit
		Damage of wiring of the Environmental temperature sensor on the outdoor unit
		Damage of the main PCB on the outdoor unit
C2	Fault with the defrosting temperature sensor on the outdoor unit	Damage of the defrosting temperature sensor on the outdoor unit
		Poor contact of the defrosting temperature sensor on the outdoor unit
		Damage of wiring of the defrosting temperature sensor on the outdoor unit
		Damage of the main PCB on the outdoor unit
C3	Fault with the discharge temperature sensor	Damage of the discharge temperature sensor on the outdoor unit
		Poor contact of the discharge temperature sensor on the outdoor unit
		Damage of wiring of the discharge temperature sensor on the outdoor unit
		Damage of the main PCB on the outdoor unit
C6	Fault with the suction temperature sensor	Damage of the suction temperature sensor on the outdoor unit
		Poor contact of the suction temperature sensor on the outdoor unit
		Damage of wiring of the suction temperature sensor on the outdoor unit
		Damage of the main PCB on the outdoor unit

Fault code	Fault description	Causes of possible failure
C8	Fault with the temperature sensor in the middle of outdoor condenser	Damage of the temperature sensor on the outdoor unit
		Poor contact of the temperature sensor on the outdoor unit
		Damage of wiring of the temperature sensor on the outdoor unit
		Damage of the main PCB on the outdoor unit
J2	Communication error between the outdoor unit and the indoor unit	Damage of the main PCB on the indoor unit
		Damage of the main PCB on the outdoor unit
		Poor wiring
J3	Communication error between the driver PCB and main PCB of the outdoor unit	Damage of the driver PCB on the outdoor unit
		Damage of the main PCB on the outdoor unit
		Poor wiring
J7	Fault with the outdoor unit EPROM	Chip damage
E1	Fault of four way valve	Damage of four-way valve
		Damage to coil of four-way valve
E3	Protection high temperature discharge	Lack of the refrigerant
		Stop valve unopened
		Damage of the main PCB on the outdoor unit
E8	Fault with anti-high temperature protection of indoor unit in heating model	Outdoor condenser viscera
		Indoor evaporator viscera
FH	Protection lower temperature discharge	Temperature sensor shedding
		Damage of the main PCB on the outdoor unit
31	Fault with the inverter module protection	Fault with the inverter module protection
32	Compressor drive hardware protection	Damage of the EE chip of driver board
33	Module software protection	Supply voltage below level let the current excessive
		Supply voltage exceed limit
		Outdoor fan stop or low speed
34	Compressor start failure	Compressor power line not connected
35	Fault with the over-electric current protection	Excessive running current of the unit
		Voltage drops abruptly in operation
36	Fault with the over-voltage or low voltage protection	Excessive input voltage
		Lower input voltage
37	Fault with the modular temperature sensor on the outdoor unit	Sensor damage of compressor IPM module
38	Fault with the Compressor Power supply Phase deficiency protection	Compressor power line not connected
39	Protection of compressor driving module for excessive temperature	Poor contact between compressor IPM module and radiator
3H	Fault with the Fan motor 1 of outdoor unit	Damage of motor
5H	Fault with the Fan motor 2 of outdoor unit	Damage of motor
3C	Overcurrent protection of outdoor DC motor	High speed of DC motor
3J	Overvoltage protection of outdoor DC motor	Low voltage output
3E	Compressor drive PFC software protection	Excessive running current of the unit
		Voltage drops abruptly in operation
3F	Compressor drive PFC hardware protection	Damage of the PFC circuit components
		Reactor damage
41	IPM protection for driving board of outdoor DC fan	Damage of IPM components of DC fan
99	Communication error between the driver PCB and main PCB of the indoor unit	Abnormal power supply of fan driving board
		Poor contact of the communication line of fan drive board
		Damage of fan driving board
9A	Temperature protection of indoor DC fan module	Damage of fan driving board
9H	Failure of indoor DC fan start-up	Damage of fan motor
		High speed of DC motor
9C	Overcurrent protection of indoor DC motor	Excessive running current of fan motor
9J	Overvoltage and undervoltage protection of indoor DC motor	Excessive input voltage
		Lower input voltage
9E	IPM protection for driving board of indoor DC fan	Sensor damage of DC motor IPM module
9F	EE protection for driving board of indoor DC fan	Damage of EE chip of Driver board

## Fault code - Constant speed

When the air conditioner fails, the controller board's timing receiver, the outdoor unit PCB board's trouble light and the wired controller's LCD panel will show the corresponding fault code according to the different fault indication. Specific response is as follows:

Fault code	Display type	Fault description	Causes of possible failure
E0	Blink 11 times, stop 2 seconds	Lack of refrigerant	Compressor internal protection
			System less refrigerant
			Reversing failure of 4 way valve
E1	Blink 1 times, stop 2 seconds	TA (Indoor temperature sensor) is abnormal	Sensor damage
			Poor contact of sensor
E2	Blink 2 times, stop 2 seconds	TW (Defrosting temperature sensor) is abnormal	Sensor damage
			Poor contact of sensor
E3	Blink 3 times, stop 2 seconds	TE (Indoor coil sensor) is abnormal	Sensor damage
			Poor contact of sensor
E4	Blink 4 times, stop 2 seconds	Drainage system failure	Damage of water pump
			Damage of float switch
			Float switch is locked
E5	Blink 5 times, stop 2 seconds	Communication failure	Communication line sequence error
			Bad contact of communication line
E6	Blink 6 times, stop 2 seconds	Outdoor protection (phase sequence)	The power line is short of phase
			Power line phase sequence error
E7	Blink 7 times, stop 2 seconds	TL (Outdoor condensing temperature sensor) is abnormal	Sensor damage
			Poor contact of sensor
E8	Blink 8 times, stop 2 seconds	TP (Discharge temperature sensor) is abnormal	Sensor damage
			Poor contact of sensor
E9	Blink 9 times, stop 2 seconds	Low pressure protection	System less refrigerant
EA	Blink 10 times, stop 2 seconds	Outdoor protection (Discharge temperature is too high.)	External protection device action
F1	Blink 5 times, stop 2 seconds	Communication failure between indoor unit and outdoor unit	Communication line sequence error
			Bad contact of communication line
F2	Blink 2 times, stop 2 seconds	Exhaust overtemperature protection	System plugging or fault of the outdoor fan
F3	Blink 3 times, stop 2 seconds	Outdoor fan 1# is abnormal	Bad connection of fan connection
			Motor damage
F4	Blink 4 times, stop 2 seconds	Indoor fan is abnormal	Bad connection of fan connection
			Motor damage
F5	Blink 5 times, stop 2 seconds	Outdoor temperature sensor	Sensor damage
			Poor contact of sensor
F6	Blink 6 times, stop 2 seconds	Compressor overcurrent protection	Compressor plugging
			Low voltage
F7	Blink 7 times, stop 2 seconds	Dial switch is abnormal	Dial switch is wrong
F8	Blink 8 times, stop 2 seconds	Indoor power protection	Wiring error
F9	Blink 9 times, stop 2 seconds	High pressure protection	The clogging of the condenser
			Abnormal operation of the outdoor fan
			System plugging
39	Blink 9 times, stop 8 seconds	Fault with the compressor power supply is lack of phase/inverse phase	Compressor power line is poor contact or disconnected or connected incorrectly

**Note:** When the wired controller or control board consecutive two minutes had not received the right signals, then the unit is turned off and instructed corresponding fault code. Once the communication restore, the unit automatically resume.

## Maintenance and service

### ● At the beginning of each season you should check

1. There are no physical obstructions at the air inlet or outlet of either indoor or outdoor unit. These will prevent the unit from operating correctly and cause seriously damage to your unit.
2. The electrical cables are in good condition, particular the earth cable. Damage must be immediately rectified by a trained person.
3. Are the drains blocked? If the drain is blocked then the unit will be prevented from operating and a seriously water leak my occur.

### ● Check at the end of service season

Operate for 2-3 hours under the ventilation condition; remove the moisture of the indoor unit.



Close power after the unit stops.

Note: When the unit is not in use for a long time, please cut-off power supply.  
If the unit is stopped by the remote controller, it will still consume some power.

### ● Other check

1. After several seasons you should have the dealer or service center clean the indoor and outdoor unit thoroughly. This will ensure the unit continues to work correctly.
2. It is possible that contaminant build up inside the unit may cause drain blockage, bad smells, water leaks and shortage of airflow, cooling or heating performance. If these occur you should have the dealer or service center clean the system and investigate.
3. Do not attempt to clean the inside of either the indoor or outdoor unit yourself. This is a hazard to health and may cause system failure.



## Fault diagnosis

### Caution

- If you experience abnormal operation such as the smell of burning, water leaks, loud noises etc. turn off the power supply and contact the dealer or service center. If you leave the unit running then major damage may occur.
- Do not attempt to service or repair the unit yourself.  
Errors by untrained personnel can cause short circuits, gas leakage and fire as well as being a serious danger to health and safety. Please have all service work done by your dealer or a trained service center.



**When there is the following phenomenon, please contact the dealer or the customer service center.**

- Unusual Sound During Operation
- Water Leakage at the indoor unit
- The unit wont respond to the controller
- Burning smells or smoke
- Failure of the electrical circuit or tripping the fuse
- Cables are abnormally hot

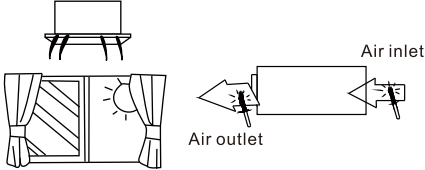

- Stop the unit and cut off power supply

In case one of the following conditions happens, please check the unit as shown below. If the problems persist, please contact the dealer or the customer service center.

Fault	Check
<p>The unit does not operate</p>	<ul style="list-style-type: none"> <li>● Has the Earth Leakage device tripped?</li> <li>● Has the circuit breaker or fuse tripped</li> <li>● Fuse tripped</li> <li>● Is the electrical Voltage normal( between 90&amp;110%)</li> </ul>
<p>The cooling or heating performance is poor</p>	<ul style="list-style-type: none"> <li>● Is the air filter dirty (if the filter has been installed)?</li> <li>● Are the air inlet and outlet blocked?</li> <li>● Are the door and window closed?</li> </ul> <p>When the unit has been running for 15 minutes, measure the temperature of the air inlet and outlet. If the two temperature differ 8°C or above during cooling and differ 14°C or above during heating, it is normal.</p> 
<p>The indoor fan does not appear to operate</p>	<ul style="list-style-type: none"> <li>● During heating or under certain other circumstances the indoor fan may slow down or stop as part of the systems normal operation.</li> </ul>
<p>Indoor Unit produces water vapour</p>	<ul style="list-style-type: none"> <li>● This can occur when the cold air from the unit meets the warm air in the room .This can occur when the cold air from the unit meets the warm air in the room.</li> </ul> 
<p>The indoor unit makes strange sounds</p>	<ul style="list-style-type: none"> <li>● When the air conditioner stops, or changes between cooling and heating modes a gurgling or whooshing sound is normally made</li> <li>● The indoor unit will expand or contract due to the temperature change and may produce creaking or groaning sounds</li> <li>● A gurgling sound is made by the flow of refrigerant through the pipes</li> </ul> 
<p>The air conditioner seems to produce unpleasant</p>	<ul style="list-style-type: none"> <li>● The air conditioner cannot produce smells by itself but odours or bacteria taken in from the room may accumulate inside the unit and produce unpleasant odours.</li> <li>● Try cleaning the air filter. If the problem persists the unit must be cleaned by a professional so please contact your dealer or service center.</li> </ul>
<p>During heating the indoor fan only operates after the unit starts heating and the operation light on the wired controller (optional) flashes.</p>	<ul style="list-style-type: none"> <li>● In order to prevent cold drafts in the room the indoor fan only runs when the air is hot during heating mode. When there is a requirement for heating and the unit starts to heat then the fan will start, after a short time.</li> <li>● The unit has a memory function, in case of a power failure, will restart after power is restored in the same mode and with the same setting as before the power failure.</li> </ul>

## Maintenance Notice

### Attention:

For maintenance or scrap, please contact authorized service centers.

Maintenance by unqualified person may cause dangers.

Feed air conditioner with R32 refrigerant, and maintain the air conditioner in strictly accordance with manufacturer's requirements. The chapter is mainly focused on special maintenance requirements for appliance with R32 refrigerant. Ask repairer to read after-sales technical service handbook for detailed information.

### Qualification requirements of maintenance personnel

1. Special training additional to usual refrigerating equipment repair procedures is required when equipment with flammable refrigerants is affected. In many countries, this training is carried out by national training organisations that are accredited to teach the relevant national competency standards that may be set in legislation. The achieved competence should be documented by a certificate.
2. The maintenance and repair of the air conditioner must be conducted according to the method recommended by the manufacturer. If other professionals are needed to help maintain and repair the equipment, it should be conducted under the supervision of individuals who have the qualification to repair AC equipped with flammable refrigerant.

### Inspection of the Site

Safety inspection must be taken before maintaining equipment with R32 refrigerant to make sure the risk of fire is minimized. Check whether the place is well ventilated, whether anti-static and fire prevention equipment is perfect. While maintaining the refrigeration system, observe the following precautions before operating the system.

### Operating Procedures

1. General work area:  
All maintenance staff and others working in the local area shall be instructed on the nature of work being carried out. Work in confined spaces shall be avoided. The area around the workspace shall be sectioned off. Ensure that the conditions within the area have been made safe by control of flammable material.
2. Checking for presence of refrigerant:  
The area shall be checked with an appropriate refrigerant detector prior to and during work, to ensure the technician is aware of potentially toxic or flammable atmospheres. Ensure that the leak detection equipment being used is suitable for use with all applicable refrigerants, i.e. non-sparking, adequately sealed or intrinsically safe.
3. Presence of fire extinguisher:  
If any hot work is to be conducted on the refrigeration equipment or any associated parts, appropriate fire extinguishing equipment shall be available to hand. Have a dry powder or CO2 fire extinguisher adjacent to the charging area.
4. No ignition sources:  
No person carrying out work in relation to a refrigeration system which involves exposing any pipe work shall use any sources of ignition in such a manner that it may lead to the risk of fire or explosion. All possible ignition sources, including cigarette smoking, should be kept sufficiently far away from the site of installation, repairing, removing and disposal, during which refrigerant can possibly be released to the surrounding space. Prior to work taking place, the area around the equipment is to be surveyed to make sure that there are no flammable hazards or ignition risks.  
'No Smoking' signs shall be displayed.
5. Ventilated Area (open the door and window):  
Ensure that the area is in the open or that it is adequately ventilated before breaking into the system or conducting any hot work. A degree of ventilation shall continue during the period that the work is carried out. The ventilation should safely disperse any released refrigerant and preferably expel it externally into the atmosphere.

#### 6. Checks to the refrigeration equipment:

Where electrical components are being changed, they shall be fit for the purpose and to the correct specification. At all times the manufacturer's maintenance and service guidelines shall be followed. If in doubt, consult the manufacturer's technical department for assistance. The following checks shall be applied to installations using flammable refrigerants:

- The charge size is in accordance with the room size within which the refrigerant containing parts are installed.
- The ventilation machinery and outlets are operating adequately and are not obstructed.
- If an indirect refrigerating circuit is being used, the secondary circuit shall be checked for the presence of refrigerant.
- Refrigeration pipe or components are installed in a position where they are unlikely to be exposed to any substance which may corrode refrigerant containing components, unless the components are constructed of materials which are inherently resistant to being corroded or are suitably protected against being so corroded.

#### 7. Checks to electrical devices:

Repair and maintenance to electrical components shall include initial safety checks and component inspection procedures. If a fault exists that could compromise safety, then no electrical supply shall be connected to the circuit until it is satisfactorily dealt with. If the fault cannot be corrected immediately but it is necessary to continue operation, an adequate temporary solution shall be used. This shall be reported to the owner of the equipment so all parties are advised.

Initial safety checks shall include:

- That capacitors are discharged: this shall be done in a safe manner to avoid possibility of sparking.
- That no live electrical components and wiring are exposed while charging, recovering or purging the system.
- Keep continuity of earthing.

### **Inspection of Cable**

Check the cable for wear, corrosion, overvoltage, vibration and check if there are sharp edges and other adverse effects in the surrounding environment. During the inspection, the impact of aging or the continuous vibration of the compressor and the fan on it should be taken into consideration.

### **Leakage check of R32 refrigerant**

Note: Check the leakage of the refrigerant in an environment where there is no potential ignition source. No halogen probe (or any other detector that uses an open flame) should be used.

Leak detection method:

For systems with refrigerant R32, electronic leak detection instrument is available to detect and leak detection should not be conducted in environment with refrigerant. Make sure the leak detector will not become a potential source of ignition, and is applicable to the measured refrigerant. Leak detector shall be set for the minimum ignitable fuel concentration (percentage) of the refrigerant. Calibrate and adjust to proper gas concentration (no more than 25%) with the used refrigerant.

The fluid used in leak detection is applicable to most refrigerants. But do not use chloride solvents to prevent the reaction between chlorine and refrigerants and the corrosion of copper pipeline.

If you suspect a leak, then remove all the fire from the scene or put out the fire. If the location of the leak needs to be welded, then all refrigerants need to be recovered, or, isolate all refrigerants away from the leak site (using cut-off valve). Before and during the welding, use OFN to purify the entire system.

### Removal and Vacuum Pumping

1. Make sure there is no ignited fire source near the outlet of the vacuum pump and the ventilation is well.
2. Allow the maintenance and other operations of the refrigeration circuit should be carried out according to the general procedure, but the following best operations that the flammability is already taken into consideration are the key. You should follow the following procedures:
  - Remove the refrigerant.
  - Decontaminate the pipeline by inert gases.
  - Evacuation.
  - Decontaminate the pipeline by inert gases again.
  - Cut or weld the pipeline.
3. The refrigerant should be returned to the appropriate storage tank. The system should be blown with oxygen free nitrogen to ensure safety. This process may need to be repeated for several times. This operation shall not be carried out using compressed air or oxygen.
4. Through blowing process, the system is charged into the anaerobic nitrogen to reach the working pressure under the vacuum state, then the oxygen free nitrogen is emitted to the atmosphere, and in the end, vacuumize the system. Repeat this process until all refrigerants in the system is cleared. After the final charging of the anaerobic nitrogen, discharge the gas into the atmosphere pressure, and then the system can be welded. This operation is necessary for welding the pipeline.

### Procedures of Charging Refrigerants

As a supplement to the general procedure, the following requirements need to be added:

- Make sure that there is no contamination among different refrigerants when using a refrigerant charging device. The pipeline for charging refrigerants should be as short as possible to reduce the residual of refrigerants in it.
- Storage tanks should remain vertically up.
- Make sure the grounding solutions are already taken before the refrigeration system is charged with refrigerants.
- After finishing the charging (or when it is not yet finished), label the mark on the system.
- Be careful not to overcharge refrigerants.

### Scrap and Recovery

#### Scrap:

Before this procedure, the technical personnel shall be thoroughly familiar with the equipment and all its features, and make a recommended practice for refrigerant safe recovery. For recycling the refrigerant, shall analyze the refrigerant and oil samples before operation. Ensure the required power before the test.

1. Be familiar with the equipment and operation.
2. Disconnect power supply.
3. Before carrying out this process, you have to make sure:
  - If necessary, mechanical equipment operation should facilitate the operation of the refrigerant tank.
  - All personal protective equipment is effective and can be used correctly.
  - The whole recovery process should be carried out under the guidance of qualified personnel.
  - The recovering of equipment and storage tank should comply with the relevant national standards.

- 4.If possible, the refrigerating system should be vacuumized.
- 5.If the vacuum state can't be reached, you should extract the refrigerant in each part of the system from many places.
- 6.Before the start of the recovery, you should ensure that the capacity of the storage tank is sufficient.
- 7.Start and operate the recovery equipment according to the manufacturer's instructions.
- 8.Don't fill the tank to its full capacity (the liquid injection volume does not exceed 80% of the tank volume).
- 9.Even the duration is short, it must not exceed the maximum working pressure of the tank.
- 10.After the completion of the tank filling and the end of the operation process, you should make sure that the tanks and equipment should be removed quickly and all closing valves in the equipment are closed.
- 11.The recovered refrigerants are not allowed to be injected into another system before being purified and tested.

Note: The identification should be made after the appliance is scrapped and refrigerants are evacuated. The identification should contain the date and endorsement. Make sure the identification on the appliance can reflect the flammable refrigerants contained in this appliance.

### **Recovery:**

- 1.The clearance of refrigerants in the system is required when repairing or scrapping the appliance. It is recommended to completely remove the refrigerant.
- 2.Only a special refrigerant tank can be used when loading the refrigerant into the storage tank. Make sure the capacity of the tank is appropriate to the refrigerant injection quantity in the entire system. All tanks intended to be used for the recovery of refrigerants should have a refrigerant identification (i.e. refrigerant recovery tank). Storage tanks should be equipped with pressure relief valves and globe valves and they should be in a good condition. If possible, empty tanks should be evacuated and maintained at room temperature before use.
- 3.The recovery equipment should be kept in a good working condition and equipped with equipment operating instructions for easy access. The equipment should be suitable for the recovery of R32 refrigerants. Besides, there should be a qualified weighting apparatus which can be normally used. The hose should be linked with detachable connection joint of zero leakage rate and be kept in a good condition.  
Before using the recovery equipment, check if it is in a good condition and if it gets perfect maintenance. Check if all electrical components are sealed to prevent the leakage of the refrigerant and the fire caused by it. If you have any question, please consult the manufacturer.
- 4.The recovered refrigerant shall be loaded in the appropriate storage tanks, attached with a transporting instruction, and returned to the refrigerant manufacturer. Don't mix refrigerant in recovery equipment, especially a storage tank.
- 5.The space loading R32 refrigeration can't be enclosed in the process of transportation. Take anti electrostatic measures if necessary in transportation. In the process of transport, loading and unloading, necessary protective measures must be taken to protect the air conditioner to ensure that the air conditioner is not damaged.
- 6.When removing the compressor or clearing the compressor oil, make sure the compressor is pumped to an appropriate level to ensure that there is no residual R32 refrigerants in the lubricating oil. The vacuum pumping should be carried out before the compressor is returned to the supplier. Ensure the safety when discharging oil from the system.

## DE-COMMISSIONING, DISMANTLING & DISPOSAL

This product contains refrigerant under pressure, rotating parts, and electrical connections which may be a danger & cause injury. All work must only be carried out by competent persons using suitable protective clothing and safety precautions.



Read the Manual



Risk of Electric Shock

**RoHS**



Unit is Remotely controlled  
& may start without warning



1. Isolate all sources of electrical supply to the unit including any control system supplies switched by the unit. Ensure that all points of electrical and gas isolation are secured in the OFF position. The supply cables and gas pipe work may then be disconnected and removed. For points of connection refer to unit installation instructions.
2. Remove all refrigerant from each system of the unit into a suitable container using a refrigerant reclaim or recovery unit. This refrigerant may then be reused, if appropriate, or returned to the manufacturer for disposal. Under NO circumstances should refrigerant be vented to atmosphere. Where appropriate, drain the refrigerant oil from each system into a suitable container and dispose of according to local laws and regulations governing disposal of oily wastes.
3. Packaged units can generally be removed in one piece after disconnection as above. Any fixing down bolts should be removed and then unit lifted from position using the points provided and equipment of adequate lifting capacity. Reference MUST be made to the unit installation instructions for unit weight and correct methods of lifting. Note that any residual or spilt refrigerant oil should be mopped up and disposed of as described above.
4. After removal from position the unit parts may be disposed of according to local laws and regulations.
5. Meaning of crossed Out wheeled dustbin: Do not dispose of electrical appliances as unsorted municipal waste, use separate collection facilities. Contact your local government for information regarding the collection systems available. If electrical appliances are disposed of in landfills or dumps, hazardous substances can leak into the groundwater and get into the food chain, damaging your health and well being. When replacing old appliances with new ones, the retailer is legally obligated to take back your old appliance for disposals at least free of charge.



1166 North Mingguang Road, Jiangshan, Yinzhou,  
Ningbo, 315191 Zhejiang, China

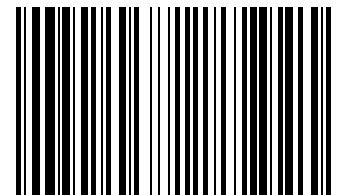

16437005000753